

Owner's Manual

Model No.
16211383550
XBR55ENT

- Assembly
- Operation
- Adjustments
- Parts
- Warranty

CAUTION:
Read and
understand this
manual before
operating unit

SPIRIT



Retain For Future Reference

TABLE OF CONTENTS

Product Registration	2
Important Safety Instructions	3
Important Electrical Instructions	5
Important Operation Instructions.....	5
Assembly Instructions.....	7
Setting Up Your Bike.....	12
About Your Machine & Using the Spirit+ App	13
Operation of Your Console.....	14
Programmable Features	15
Programs Intro.....	18
Using A Heart Rate Transmitter	25
Maintenance & Care.....	26
Exploded View Diagram	27
Parts List	28
Manufacturer's Limited Warranty	32

ATTENTION

This Recumbent Bike is intended for residential use only and is warranted for this application. Any other application voids this warranty in its entirety.

SPIRIT

CONGRATULATIONS ON YOUR NEW FITNESS BIKE

Thank you for your purchase of this quality fitness bike trainer from Dyaco Canada Inc. Your new bike was manufactured by one of the leading fitness manufacturers in the world and is backed by one of the most comprehensive warranties available. Through your dealer, Dyaco Canada Inc. will do all we can to make your ownership experience as pleasant as possible for many years to come. The local dealership where you purchased this bike is your administrator for all Dyaco Canada Inc. warranty and service needs. Their responsibility is to provide you with the technical knowledge and service personnel to make your experience more informed and any difficulties easier to remedy.

Please take a moment at this time to record the name of the dealer, their telephone number, and the date of purchase below to make any future needed contact easy. We appreciate your support, and we will always remember that you are the reason that we are in business. Please go to www.dyaco.ca/warranty and complete the online warranty registration.

Name of Dealer _____

Dealer Phone # _____

Purchase Date _____

Product Registration

RECORD YOUR SERIAL NUMBER

Please record the Serial Number of this fitness product in the space provided below.

Serial Number _____

REGISTER YOUR PURCHASE

Please visit us at www.dyaco.ca/warranty to register your purchase.

Important Safety Instructions

When using electrical equipment, basic precautions should always be followed, including the following:

WARNING - Read all instructions before using this equipment.

DANGER - To reduce the risk of electric shock: Always unplug this equipment from the electrical outlet immediately after using and before cleaning.

WARNING - To reduce the risk of burns, fire, electric shock, or injury to persons, install the Recumbent Bike on a flat level surface with access to a 115-volt, 15-amp grounded outlet with only the Recumbent Bike plugged into the circuit.

DO NOT USE AN EXTENSION CORD UNLESS IT IS A 14AWG OR BETTER, WITH ONLY ONE OUTLET ON THE END:

- Equipment should never be left unattended when plugged in. Unplug from outlet when not in use, and before putting on or taking off parts.
- Do not operate under a blanket or pillow. Excessive heating can occur and cause fire, electric shock, or injury to persons.
- This equipment is not intended for use by persons with reduced physical, sensory or mental capabilities, or lack of experience and knowledge unless they have been given supervision or instruction concerning the use of the equipment by a person responsible for their safety.
- Use this equipment only for its intended use as described in this manual. Do not use attachments not recommended by the manufacturer.
- Never operate this equipment if it has a damaged cord or plugs, if it is not working properly, if it has been dropped or damaged, or dropped into water. Return the equipment to a service center for examination and repair.
- Do not carry this equipment by supply cord or use cord as a handle.
- Keep the cord away from heated surfaces.
- Never operate the appliance with the air openings blocked. Keep the air openings free of lint, hair, and the like.
- Never drop or insert any object into any opening.
- Do not use outdoors.
- Do not operate where aerosol (spray) products are being used or where oxygen is being administered.
- Connect this equipment to a properly grounded outlet only. See Grounding Instructions.
- The equipment is intended for household use.
- To disconnect, turn all controls to the off position, then remove the plug from the outlet.
- Do not operate equipment on deeply padded, plush or shag carpet. Damage to both carpet and equipment may result.
- Before beginning this or any exercise program, consult a physician. This is especially important for persons over the age of 35 or persons with pre-existing health conditions.
- Keep hands away from all moving parts.
- The pulse sensors are not medical devices. Various factors, including the user's movement, may affect the accuracy of heart rate readings. The pulse sensors are intended only as exercise aids in determining heart rate trends in general.
- Do not attempt to use your equipment for any purpose other than for the purpose it is intended.

- Wear proper shoes. High heels, dress shoes, sandals or bare feet are not suitable for use on your equipment. Quality athletic shoes are recommended to avoid leg fatigue.
- Close supervision is necessary when this equipment is used by, on, or near children, invalids, or disabled persons.
- Keep children under the age of 13 away from this machine.
- **The Recumbent Bike is not a medical device.**

Please ensure that you review and adhere to the user weight restrictions and power requirements of your new machine. Failure to do so may result in serious injury or damage to your machine.

Important Electrical Instructions

WARNING!

Route the power cord away from any moving part of the unit including the transport wheels.

NEVER remove any cover without first disconnecting the DC power. If voltage varies by ten percent (10%) or more, the performance of your unit may be affected. Such conditions are not covered under your warranty. If you suspect the voltage is low, contact your local power company or a licensed electrician for proper testing.

NEVER expose this unit to rain or moisture. This product is NOT designed for use outdoors, near a pool or spa, or in any other high-humidity environment. The operating temperature specification is 40 to 120 degrees Fahrenheit, and humidity is 95% non-condensing (no water drops forming on surfaces).

Optimally the unit should be the only device plugged into the circuit. Our units have surge suppressors built in to help avoid nuisance tripping. We have tested several AFCI/GFCI breakers and outlets with our products. Brands we have tested are Eaton (Cutler Hammer Series), Leviton (Smart lock pro) and Schneider Electric (Canadian home series). These breakers do not trip in our testing, when connected to our units, as long as no other devices are plugged into the same circuit.

Important Operation Instructions

- **NEVER** operate this unit without reading and completely understanding the results of any operational change you request from the computer.
- **NEVER** use your unit during an electrical storm. Surges may occur in your household power supply that could damage unit components. Unplug the unit during an electrical storm as a precaution.
- Understand that changes in resistance do not occur immediately. Set your desired resistance level on the computer console and release the adjustment key. The computer will obey the command gradually.
- Use caution while participating in other activities while pedaling on your Recumbent Bike; such as watching television, reading, etc. These distractions may cause you to lose balance which may result in serious injury.
- Do not use excessive pressure on console control keys. They are precision set to function properly with little finger pressure.

WARNING DECAL REPLACEMENT

The decal shown below has been placed on the bike. If the decal is missing or illegible, please call our Customer Service Department toll-free at 1-888-707-1880 to order a replacement decal.

⚠ WARNING / AVERTISSEMENT

Model/Modèle#: [REDACTED]
Serial#/Numéro de série: [REDACTED]

**For consumer use only.
Max user weight limit**

ATTENTION: (Max. 130 kg)

CAUTION: SMALL CHILDREN AND PERSONS PHYSICALLY HANDICAPPED SHOULD NOT USE ANY EXERCISE EQUIPMENT WITHOUT A QUALIFIED PERSON IN ATTENDANCE. WARNING: KEEP CHILDREN AWAY FROM THE [REDACTED]. KEEP BODY AND CLOTHING FREE AND CLEAR OF ALL MOVING PARTS. THE POSSIBILITY OF SERIOUS INJURIES OR DEATH IF CAUTION IS NOT USED. READ ALL WARNINGS AND INSTRUCTIONS PRIOR TO USE. REPLACE LABEL IF DAMAGED, ILLEGIBLE OR REMOVED.

**Usage à des fins personnelles seulement
poids maximum de l'utilisateur**

ATTENTION: (Max. 130 kg)

ATTENTION: LES ENFANTS ET LES PERSONNES AVANT UN HANDICAP PHYSIQUE NE DOIVENT UTILISER AUCUN APPAREIL D'EXERCICE SANS LA SURVEILLANCE D'UNE PERSONNE QUALIFIÉE.

AVERTISSEMENT: GARDER LES ENFANTS À L'ÉCART DU [REDACTED]. GARDER LE CORPS ET LES VÊTEMENTS ÉLOIGNÉS DE TOUTE PIÈCE MOBILE. LE DÉFAUT DE VIGILANCE DANS L'UTILISATION DE CET APPAREIL, POURRAIT ENTRAÎNER DE GRAVES BLESSURES ET MÊME LA MORT. LIRE TOUTS LES AVERTISSEMENTS ET TOUTES LES DIRECTIVES AVANT UTILISATION. REMPLACER TOUTE ÉTIQUETTE ENDOMMAGÉE, ILLISIBLE OU MANQUANTE.

**Dyaco Canada Inc.
5955 Don Murie St
Niagara Falls, Ontario
L2G 0A9**

**Customer Service
Service à la clientèle
1-888-707-1880**

ASSEMBLY INSTRUCTIONS

PRE-ASSEMBLY

**!!ATTENTION: IMPORTANT UNPACKING INSTRUCTIONS.
PLEASE READ BEFORE UNPACKING YOUR FOLDING RECUMBENT BIKE!!**

1. Using a razor knife (Box Cutter), cut the banding straps that wrap around the carton. Reach under the bottom edge of the carton and pull it away from the cardboard underneath, separating the staples that join the two together. Lift the box over the unit and unpack.
2. Carefully remove all parts from the carton and inspect for any damage or missing parts. If damaged parts are found, or parts are missing, contact your dealer immediately.
3. Locate the hardware package. The hardware is separated into four steps. Remove the tools first. Remove the hardware for each step as needed to avoid confusion. The numbers in the instructions that are in parenthesis (#) are the item number from the assembly drawing for reference.

ASSEMBLY TOOLS

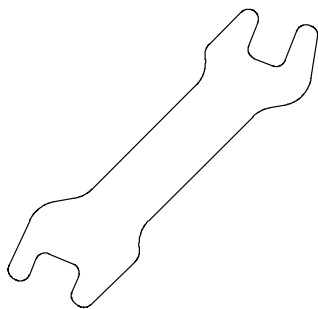

#112. 12/14mm Wrench

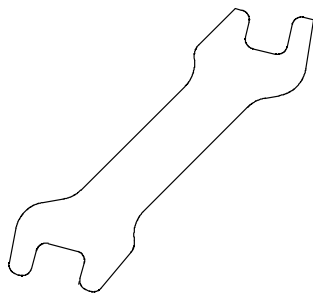

#113. 13/15mm Wrench

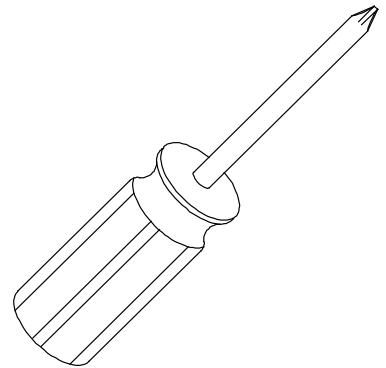

#114. Phillips Head Screwdriver

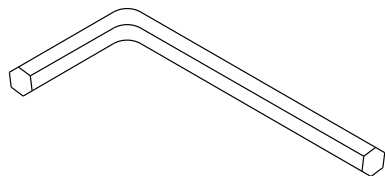

#115. Allen Wrench

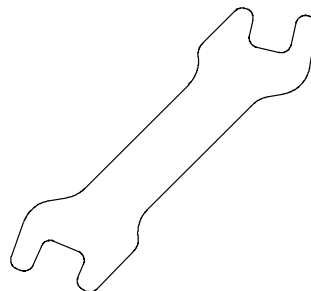

#130. 13/14mm Wrench

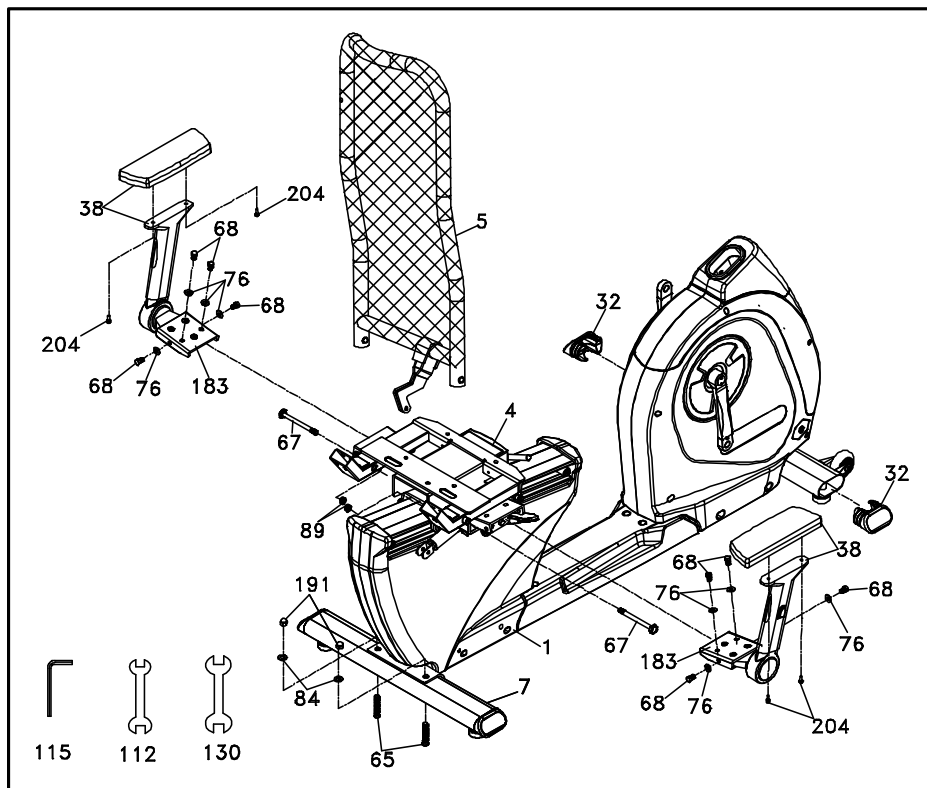

STEP 1:

1. Attach the **REAR STABILIZER (7)** to the **MAIN FRAME (1)** with **2 BOLTS (65)** and **2 FLAT WASHERS (84)** and **2 CAP NUTS (191)**. Tighten completely with the **WRENCH (112)**.
2. Install the **HANDGRIP (L.R) (38)** with **4 BOLTS (204)** by using the **WRENCH (115)**.
3. Attach the **LOCKING PLATE (183)** to the **SEAT CARRIAGE (4)** with **8 BOLTS (68)** and **8 FLAT WASHERS (76)**. Tighten with the **WRENCH (112)**.
4. Attach the **SEAT BACK (5)** to the **SEAT CARRIAGE (4)** of the main frame. Slide **1 BOLT (67)** through each side, then attach a **NYLON NUT (89)** to each bolt. Tighten the bolts just enough so there is no side-to-side play, but freedom of movement front to back. Use the **WRENCHES provided (112 & 130)**.
5. Insert an **END CAP (32)** into each opening of the **Front Stabilizer Tube**. You may need to tap them in with a rubber mallet if they are tight.

HARDWARE

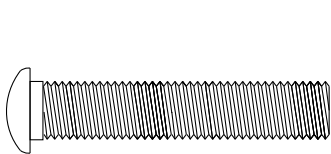

#65. 3/8" x 53mm
Carriage Bolt (2 pcs)

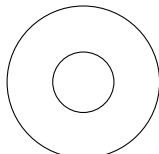

#84. 3/8" x 25 x 2T
Flat Washer (2 pcs)

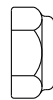

#89. 3/8" x 7T
Nylloc Nut (2 pcs)



#191. 3/8"
Cap Nut (2 pcs)

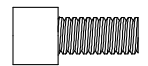

#204. M6 x 12L
Socket Head Cap Bolt
(4 pcs)

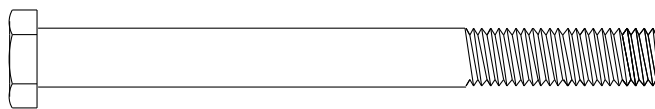

#67. 3/8" x 4"
Hex Head Bolt (2 pcs)

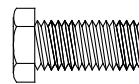

#68. 5/16" x 5/8"
Hex Head Bolt (8 pcs)

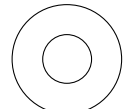

#76. 5/16" x 18 x 1.5T
Flat Washer (8 pcs)

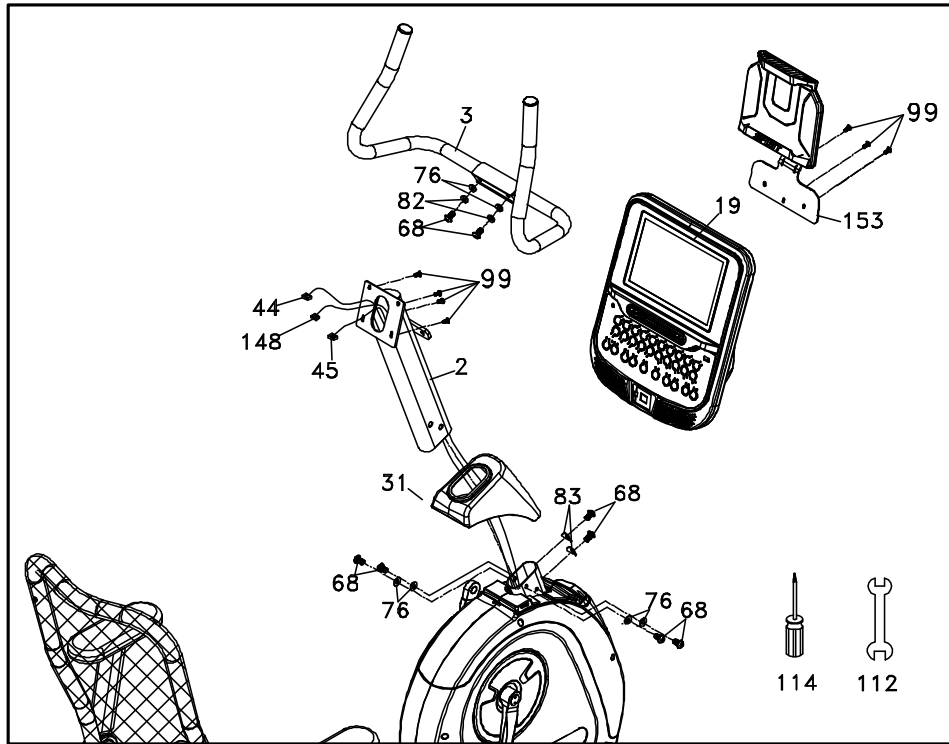

STEP 2:

1. Slide the **COMPUTER CABLE (44)**, **SWITCH CABLE (UPPER) (148)**, and **HAND PULSE CABLE (45)** through the bottom of the **CONSOLE MAST COVER (31)** and then the bottom of the **CONSOLE MAST (2)**. Make sure the Console Mast Cover is correctly oriented (see illustration).
2. Install the **CONSOLE MAST (2)** into the receiving tube (make sure not to pinch cables; damage to the electronics could occur) of the **MAIN FRAME (1)**. Insert **2 BOLTS (68)** and **2 FLAT WASHERS (76)** on each side. Insert **2 BOLTS (68)** and **2 CURVED WASHERS (83)** on the front. Tighten all 6 bolts firmly with the **WRENCH (112)**. Remove the white Styrofoam pad (factory installed to prevent bolts from being accidentally dropped into the Console Mast Tube).
3. Insert the **COMPUTER CABLE (44)**, **SWITCH CABLE (UPPER) (148)**, and **HAND PULSE CABLE (45)** into their respective connectors in the back of the **CONSOLE ASSEMBLY (19)**. Attach the console onto the mounting plate with **4 PHILLIPS HEAD SCREWS (99)**. Tighten with the **PHILLIPS HEAD SCREWDRIVER (114)**.
4. Attach the **CONSOLE HOLDER (153)** to the **CONSOLE ASSEMBLY (19)** with **3 PHILLIPS HEAD SCREWS (99)**. Tighten with the **PHILLIPS HEAD SCREWDRIVER (114)**.
5. Attach the **HANDLEBAR ASSEMBLY (3)** onto the **CONSOLE MAST (2)** bracket with **2 BOLTS (68)**, **2 SPLIT WASHERS (82)**, and **2 FLAT WASHERS (76)**. Completely tighten with the **WRENCH (112)**.

HARDWARE



#68. 5/16" x 5/8"
Hex Head Bolt (8 pcs)

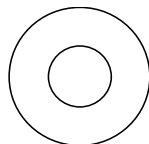

#76. 5/16" x 18 x 1.5T
Flat Washer (6 pcs)



#82. 5/16" x 1.5T
Split Washer (2 pcs)

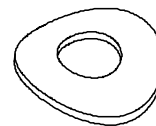

#83. 5/16" x 19 x 1.5T
Curved Washer (2 pcs)

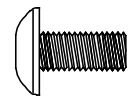

#99. M5 x 12mm Phillips
Head Screw (7 pcs)

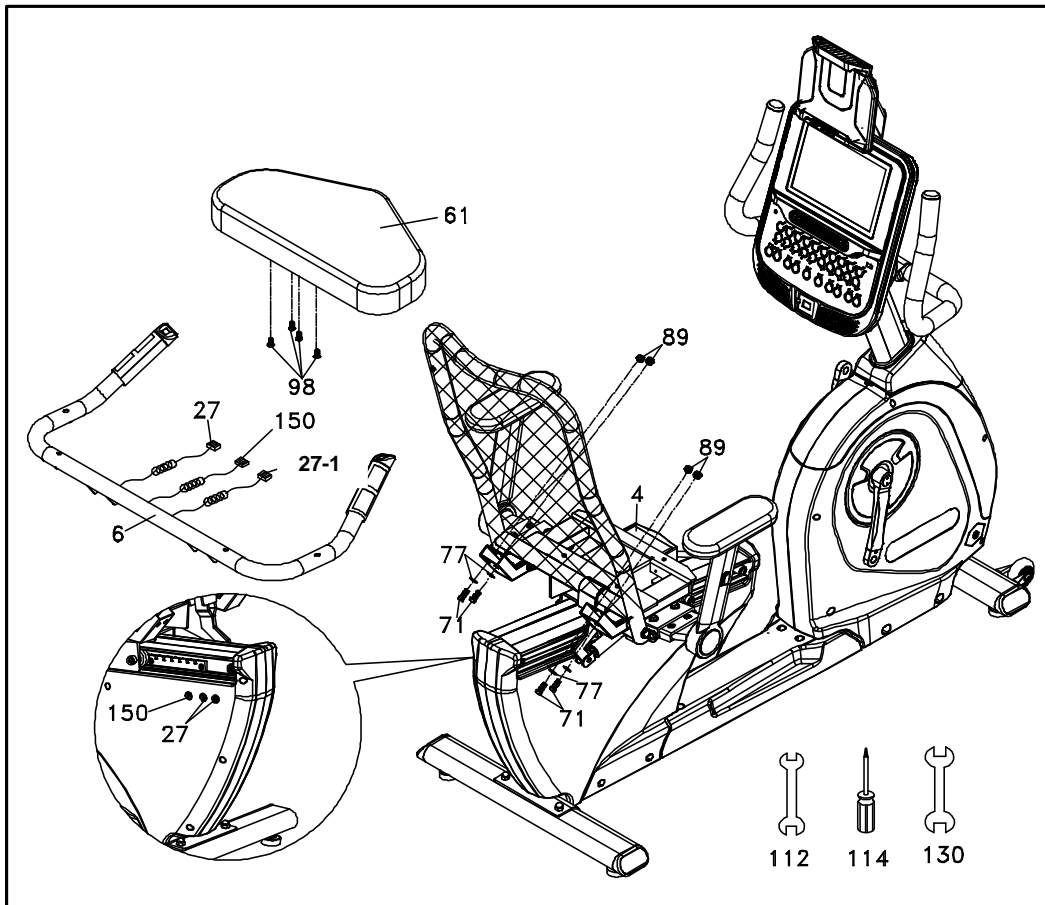

STEP 3:

1. Install the **SEAT (61)** on the **SEAT CARRIAGE (4)** with **4 PHILLIPS HEAD SCREWS (98)**. Tighten with the **PHILLIPS HEAD SCREWDRIVER (114)**.
2. Attach the **SEAT HANDLEBAR (6)** to the **SEAT CARRIAGE (4)** with the **4 Hex Head Bolts (71)**, **4 FLAT WASHERS (77)**, and **4 NYLON NUTS (89)**. Tighten with the **WRENCHES provided (112 & 130)**.
3. Plug the **HAND PULSE SENSOR CABLES (27) (27-1)** into the rear two holes on the left side of the rear plastic cover. Plug the **HANDLEBAR RESISTANCE CABLE (150)** into the remaining front hole.

HARDWARE

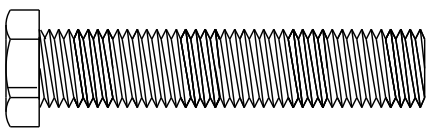

#71. 3/8" × 1-3/4"
Hex Head Bolt (4 pcs)

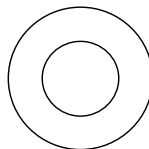

#77. 3/8" × 19 × 1.5T
Flat Washer (4 pcs)

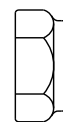

#89. 3/8" × 7T
Nylloc Nut (4 pcs)

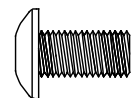

#98. M6 × 15mm Phillips
Head Screw (4 pcs)

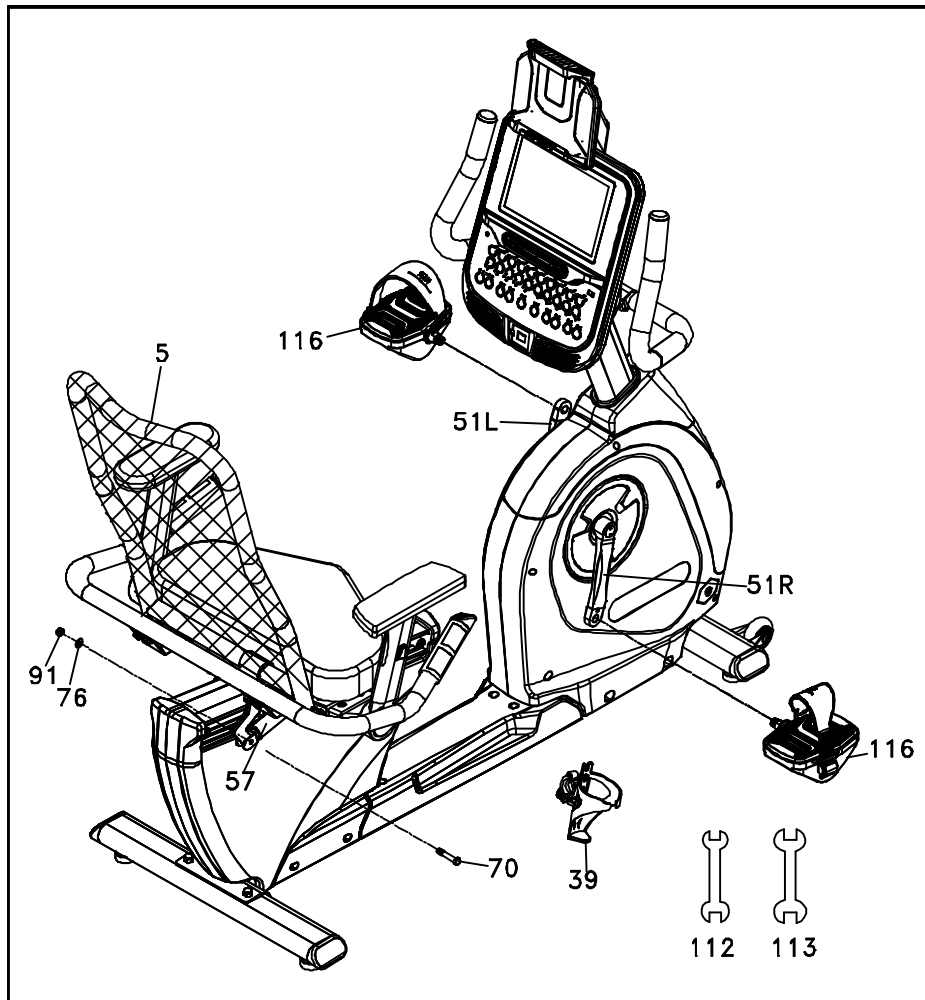

STEP 4:

1. Install the **GAS CYLINDER (57)** on the **SEAT BACK FRAME (5)** with **1 BOLT (70)**, **1 FLAT WASHER (76)** and **1 NYLON NUT (91)** by using the **WRENCHES** provided (**112 & 113**).
2. Attach the **DRINK BOTTLE HOLDER (39)** to the **SEAT HANDLEBAR (6)**.
3. Attach the **PEDALS (116)** to the **CRANK ARMS (51L, 51R)**. Tighten with the **WRENCH (113)**. Remember that the **LEFT PEDAL** has a reverse thread and will be threaded onto the Crank arm in a **COUNTERCLOCKWISE** motion. There is an "L" stamped at the end of the threaded post of the left pedal and an "R" on the right. Make sure to tighten the pedals as firmly as you can. It may be necessary to re-tighten the pedals if you feel a thumping while pedalling the bike. A thumping or clicking noise is usually caused by loose pedals.

HARDWARE

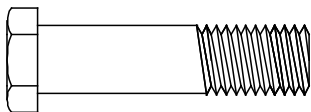

#70. 5/16" x 1-1/4"
Hex Head Bolt (1 pc)

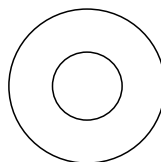

#76. 5/16" x 18 x 1.5T
Flat Washer (1 pc)



#91. 5/16" x 6T
Nyloc Nut (1 pc)

Setting Up Your Bike

■ Levelling

Use a M14 Wrench to adjust the height of the Leveling Feet.



■ Moving The Recumbent Bike

The Bike is equipped with 2 transport wheels on the front stabilizer. Lift the bike with the rear stabilizer and gently tilt the bike up and roll it away.



ABOUT YOUR RECUMBENT BIKE

Always use care and caution when operating your recumbent bike. Follow the instructions in this manual ensure the safe operation and maintenance of your recumbent bike.

Your new Spirit Fitness recumbent bike has Bluetooth connectivity to give you access to the most advanced workout experiences available. Follow the instructions below to learn more about using the Bluetooth capabilities to their fullest potential.



Downloading the Spirit+ app will help unlock more features- such as tracking workouts and sharing data via Google Fit and Apple Fitness. Simply search for “Spirit+” in the app store on your smartphone or tablet or scan the QR code below.

Did you know that you can personalize your experience with your new recumbent bike? Create a profile and save custom work- out programs by following the instructions below.

USING THE SPIRIT+ APP

In order to help you achieve your exercise goals, your new recumbent bike comes equipped with a Bluetooth® transceiver that will allow it to interact with selected phones or tablet computers via the Spirit+ App. Just download the free Spirit+ App from the Apple Store or Google Play, and then follow the instructions in the App to sync with your recumbent bike.

Press the “DISPLAY” button from the APP to view the display of the current workout data. When your exercise is complete, choose “END & SAVE WORKOUT” to store the workout data. The Spirit + App also allows you to sync your workout data with one of many fitness cloud sites we support Apple Health, Google Fit, MapMyFitness or Fitbit, with more to come.

1. Download the App by scanning the QR code on the right.
2. Open the App on your device (phone or tablet) and make sure Bluetooth® is enabled on your device (phone or tablet).
3. In the App click the Bluetooth® icon to search for your Spirit + equipment.
4. Under the Bluetooth® scan result list, select the recumbent bike for connection. When the App and equipment are synced, the Bluetooth® icon on the equipment’s console display will light up. Click “DISPLAY”, you may now start using your Spirit + App.
5. When your exercise is complete, choose “END & SAVE WORKOUT” to store the workout data. You will be prompted to sync your data with each available fitness cloud site. Please note, you will have to download the applicable compatible fitness App, such as Apple Health, Google Fit, MapMyFitness, Fitbit, etc., for the icon to be active and available.



Note: Your device will need to be running on a minimum operating system of IOS 13.1 or Android 8.0 for the Spirit + App to operate properly.

The exercise equipment can also play music wirelessly via Bluetooth®. Turn on your mobile phone or tablet’s Bluetooth® function. Search for the name “Bt-speaker” in your device’s Bluetooth® menu. Tap to connect. Now your device can transmit music to the exercise equipment.

The icon  lights up and the heart rate is displayed when successfully connected to a Bluetooth® heart rate chest strap. The icon will be off when the Bluetooth® heart rate chest strap is disconnected.

OPERATION OF YOUR CONSOLE



Powering On

When the power cord is connected to the equipment, the console will automatically power up.

Quick Start

After the console powers up you just press **Start Workout** on the screen or press the **Start** key to begin. This will initiate the Quick Start mode. In Quick Start the Time will count up from zero and the workload may be adjusted manually by pressing the **Level + / - buttons**. The dot matrix display will have only the bottom row lit at first. As you increase the workload more rows will light indicating a harder workout. The fitness bike will get harder to pedal as the rows increase.

There are 20 levels of resistance available for plenty of variety. The first 5 levels are very easy workloads and the changes between levels are set to a good progression for de-conditioned users. Levels 6-10 are more challenging, but the increases in resistance from one level to the next remain small. Levels 11-15 start getting tougher as the levels jump more dramatically. Levels 16-20 are extremely hard and are good for short-interval peaks and elite athletic training.

FEATURES

Basic Information

The **Stop** button has several functions. Pressing the **Stop** key once during a program will pause the program for 5 minutes. If you need to get a drink, answer the phone or do any of the many things that could interrupt your workout, this is a great feature. To resume your workout during Pause, just press the **Start** key. If the **Stop** button is pressed twice during a workout, the program will end and the console will display your Workout Summary (Total time, Avg. Speed, Avg. Power, Avg. HR, total Laps).

Built-in Fan

The console includes a built-in fan to help keep you cool. To turn the Fan on, press the key on the left side of the console.

Audio Jack

There is an Audio output Jack on the front of the console and built-in speakers. The output jack is a headphone jack for private listening.

Charge Portable Devices with USB port

Charge your device during your workout using the fitness equipment's on-console USB port. To charge your mobile electronics make sure the fitness equipment power is on.

Step 1: Connect your USB charging cable (not included) to the USB Power Port and your device.
Step 2: Check to make sure your device icon indicates it is charging.

NOTE:

- USB charging cable is not included, make sure a compatible USB charging cable is being used.
- The USB port on the console is capable of powering USB devices. It provides up to 5Vdc/1.0 amp of power and meets USB 2.0 regulations. You will not be able to save your workout data to a USB via this port; it is used for charging purposes only.



Direct Resistance Buttons

You can set your resistance level setting quickly by pressing the buttons on the console. Simply choose the desired level of resistance from the console and the Recumbent Bike will automatically adjust to that level. This saves time because you don't have to press and hold or hold a button down until reaching the desired value.

Pulse Grip Feature

The Pulse (Heart Rate) console window will display your current heart rate in beats per minute during the workout. You must use both stainless-steel sensors on the front cross bar or the heart rate transmitter chest strap to display your pulse. Pulse value displays anytime the upper display is receiving a Pulse signal. You may not use the Grip Pulse feature while in Heart Rate Programs.

TOUCHSCREEN

Use the touchscreen console to select from a variety of preset workout programs and fitness tests, and to enjoy the media content of your choice while on the go.

Getting Started

When launched for the first time, the console will prompt you to either enter as a guest or create a new profile. It is recommended to set up your profile: it allows your machine to remember your physical parameters and favourite programs; you will have your custom programs with adjustable intensity patterns, and your workout records can be synchronized with the SPIRIT+ mobile app. Tap + to create a new profile. A maximum of 9 profiles can be created. Each profile can be protected with a passcode.

To link a SPIRIT+ account, scan the QR code on the console screen to download the mobile app first. Once the app is installed and the registration is complete, press “Link” on the bottom of the console screen, then open the QR code scanning camera in your SPIRIT+ app and scan the QR code once again to link your local profile with the SPIRIT+ account. Please keep in mind that your console profile cannot be linked to multiple SPIRIT+ accounts at the same time. If you skip this step, you can access it again later in Profile settings.

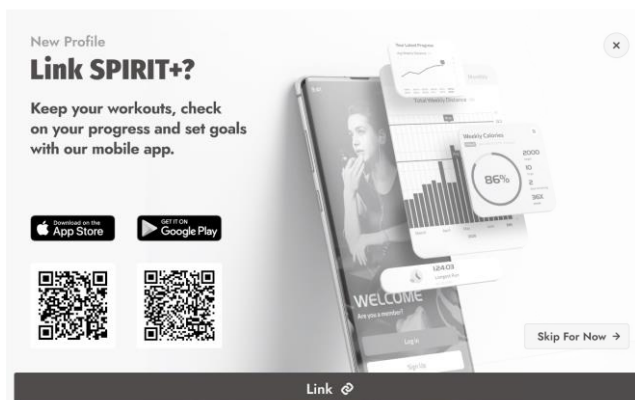
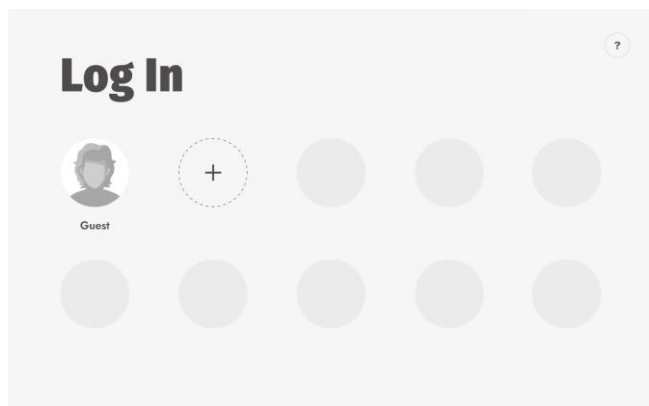

Home Screen

The main screen of the Training section displays an overview of your activity, and offers shortcuts to the most frequently used training modes: an immediate Start, a manually controlled timed workout (“Set Timer”), and up to 3 programs that you have marked as your favourites are arranged on this page for your quick access.

If in the Guest mode, you can set your age and weight here; it will help the machine calculate your workout summary more accurately.

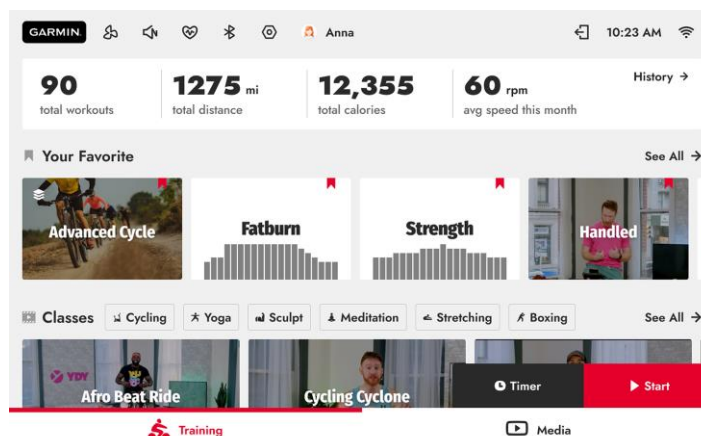

TOUCHSCREEN OPERATION

Media

Tap on the right tab of the bottom panel to access the Media section. Choose from a variety of pre-installed third-party Apps, or use the Mirroring function to cast the content from your smartphone directly to the console screen. For detailed instructions, press the ? icon.

Once the content is on, use the floating panel for navigation and operating full-screen mode. Touch the panel's top edge and drag the panel around the screen to find the perfect place for it, where it will not prevent you from interacting with the content. Press Hide Panels to enter the full-screen mode without stats on the top and tabs on the bottom and Show Panels to bring them back. Use the arrow button on the right side of the panel to hide & show the text labels: it allows you to further minimize the panel's size. Press "Apps" to go back to the content sources selection.



Workout Mode

Once the workout has been started, the console will appear in its workout mode.

During the workout, switch between **Stats**, **Charts** and **Track** views of the Training section, or go to the Media section to enjoy your favourite media content. In the Stats view, you can select the parameters you would like to display by tapping on the number.

Please use physical keys to adjust the level. Press the physical **"STOP"** key to pause the workout. Here, you can get back to training, start a cool down, or end your workout and see the summary. After 5 minutes of inactivity in the Pause mode, the workout will end automatically.

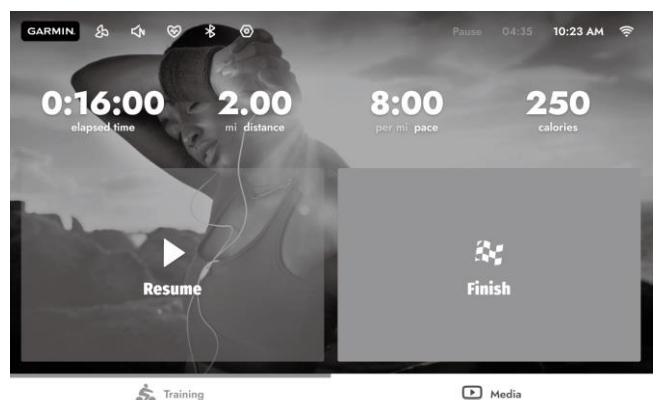

PROGRAMS INTRO

Workout Programs

To access all available categories of programs, press “All Programs” on the Home screen. Once inside, switch between categories using the tabs on the top of the screen: Preset, Targets, Fitness Tests, Custom and Favorites.

Tap on any of the program cards to open a Program Setup page, where you can learn more about the program, set properties of your workout, or keep browsing by pressing on the arrow buttons in the upper top right corner of the screen. To adjust workout parameters, you can drag the ruler, tap on the + and – buttons, or tap on the number to open a numpad and input the value directly.

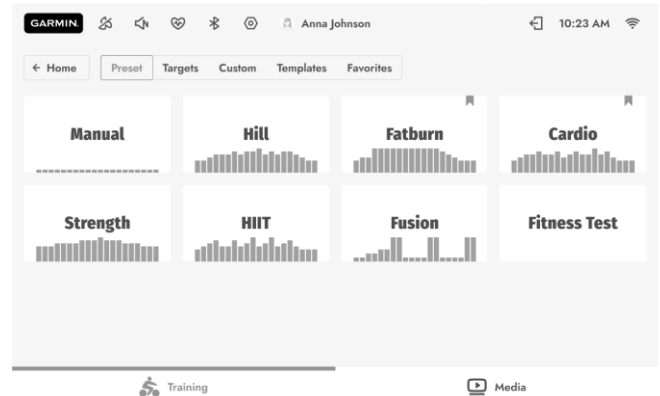

Manual

Manual (Timer) program is a timed workout with speed and incline controlled manually at any time during the workout.

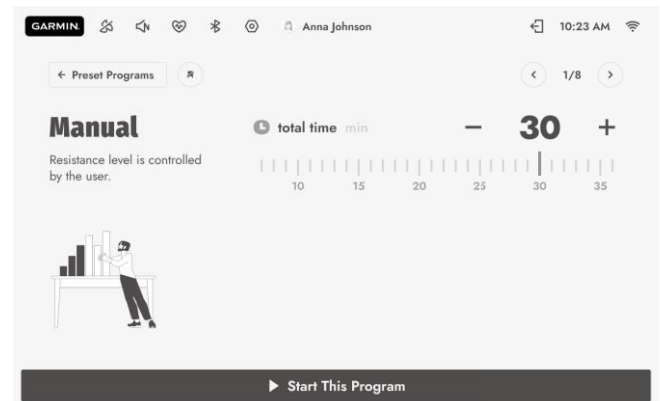

PROGRAMS - PRESET

Hill, Fatburn, Cardio, Strength, HIIT

The programs HILL, FATBURN, CARDIO, STRENGTH, and HIIT feature preset speed and incline-changing patterns. The Total Time and Max Level settings define the duration and overall intensity of your workout. The built-in level of difficulty for each segment is shown in the chart on the following page.

However, if you change the maximum level on the program setup page before starting, all segments throughout the program will be adjusted proportionally.

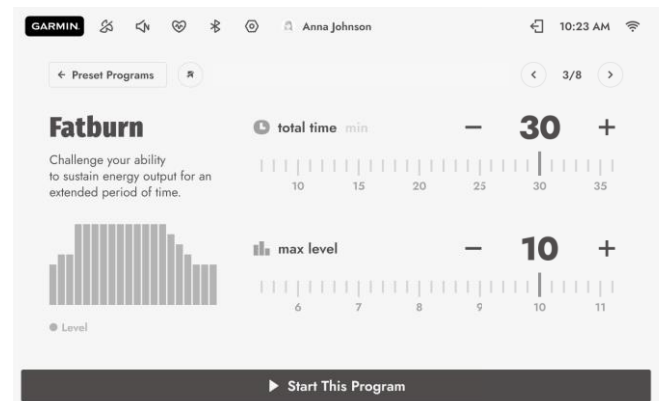

Segment	1	2	3	4	5	6	7	8	9	10	11	12	13	14	15	16	17	18	19	20
Hill	1	2	2	3	3	4	4	5	5	7	7	5	5	4	4	3	3	3	2	1
Fatburn	1	2	3	5	5	5	5	5	5	5	5	5	5	5	5	5	5	3	2	1
Cardio	1	2	3	5	6	7	6	6	6	7	6	5	6	7	6	5	6	5	2	1
Strength	1	2	2	3	3	4	4	5	5	6	7	7	8	8	8	8	8	6	4	1
HIIT	1	2	2	7	7	2	2	7	7	2	2	7	7	2	2	7	7	2	2	1

Fusion

This program takes you through high and low-intensity periods followed by strength exercises using free weights. The number of intervals, work and recovery time can all be customized for this program.

Interval	warm-up			1			2			3			4			5			Cooldown	
	Cardio	Strength	Rest	Cardio	Strength	Rest	Cardio	Strength	Rest	Cardio	Strength	Rest	Cardio	Strength	Rest	Cardio	Strength	Rest		
Level	1	2	3	max	1	1	max	1	1	max	1	1	max	1	1	max	1	1	1	1

Fitness Test

The Fitness Test is based on the YMCA Protocol and is a sub-maximal test that uses pre-determined, fixed work levels that are based on your heart rate readings as the test progresses. The test will take anywhere between 6 and 15 minutes to complete, depending on your level of fitness. The test ends when your heart rate reaches 85% of maximum at any time during the test, or if your heart rate is between 110 bpm and 85% at the end of the two consecutive stages. At the end of the test, your VO2 max score will be displayed on the console. VO2 max stands for Volume of Oxygen uptake, which is a measurement of how much oxygen you need to perform a known amount of work.

The YMCA protocol uses two to four 3-minute stages of continuous exercise. On the test setup page, make sure to fix your physical parameters if they are not correct; this information will determine the results of your test.

Before the test,

- Make sure you are in good health; check with your physician before performing any exercise if you are over the age of 35 or have any pre-existing health conditions.
- Make sure you have warmed up and stretched before taking the test.
- Avoid caffeine before the test.

Target Programs

Heart rate, Time, Distance and Calories are “target” programs, that end when the target set before start is reached. The heart rate program uses resistance to control your heart rate. The resistance level gradually increases until you reach your target heart rate, then adjusts automatically to keep you within 5 bpm of your goal. A heart rate monitor is required for this program.

On the program setup page, you can either set the target bpm directly or select 55%, 65%, 75% or 85% of your age-predicted maximum heart rate, allowing the machine to calculate your target automatically. Choosing the second option, make sure you have let the machine know how old you are, otherwise, the calculations will be based on the default values. The program is finished when the time is up, or if your heart rate is significantly higher than the target.

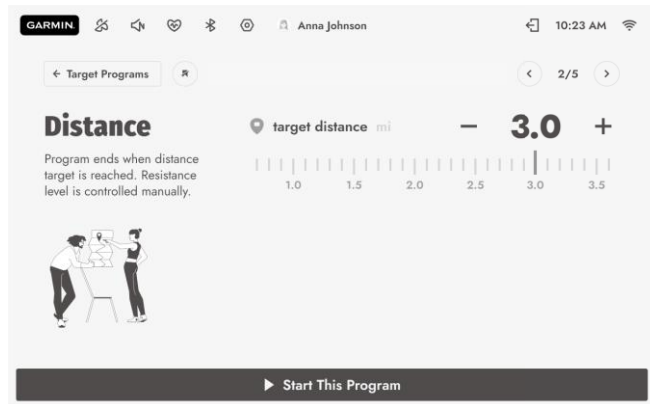
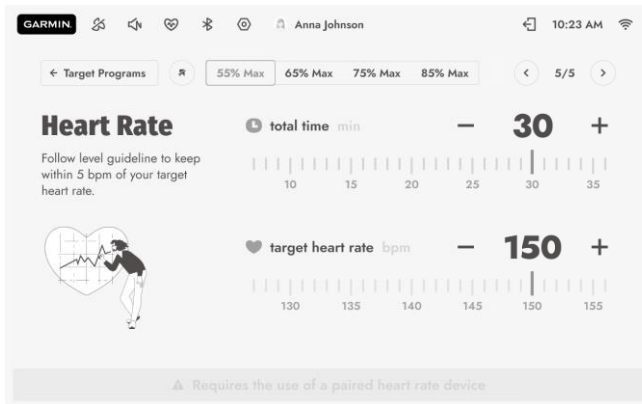

Custom

Users can create up to 8 Custom programs, each with a fully customizable level pattern. In the Custom tab, press “+ New program”, then name your program and start editing. Connect dots to map your load throughout the program, from easiest on the bottom to hardest on the top. Each segment’s duration depends on the selected total time — you can set it right before the start.

Resistance levels in the pattern are relative, and the maximum value can be set after the pattern is finished; all the segments will be adjusted proportionally.

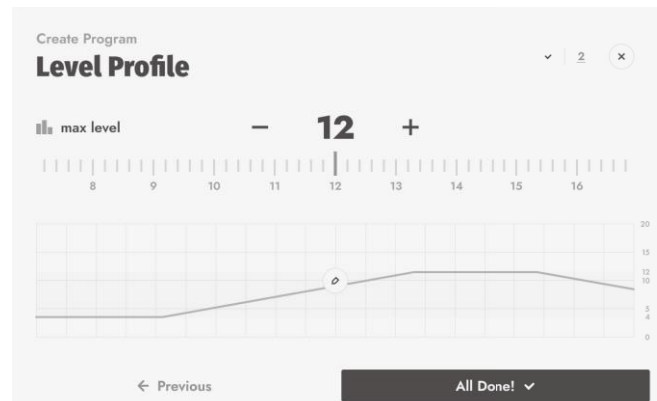
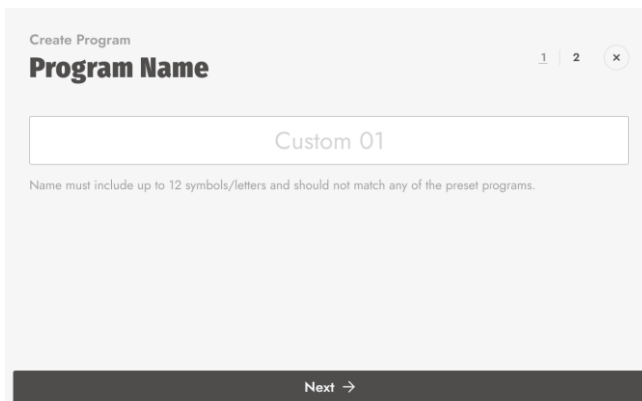

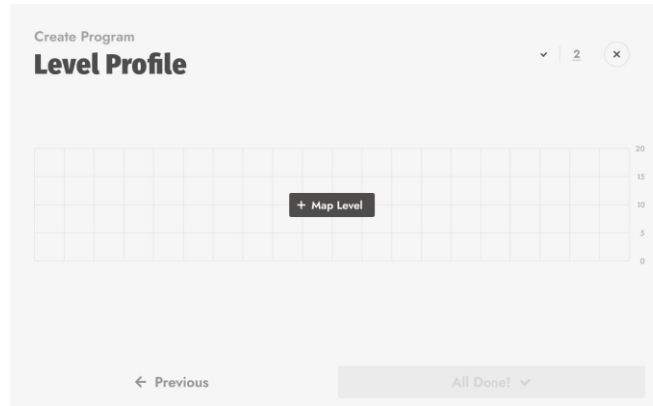
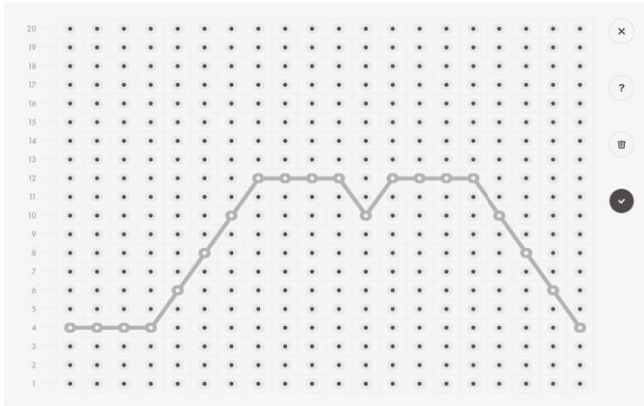

Templates

Templates are preset programs with a preserved set of parameters. Programs can be saved as templates upon completion, or you can create one from scratch in the Templates tab: tap on the “New Template” button, choose your base program, then save it with adjusted properties.

A maximum of 12 template programs can be stored. To remove the unwanted templates, press “Edit” in the Templates tab.

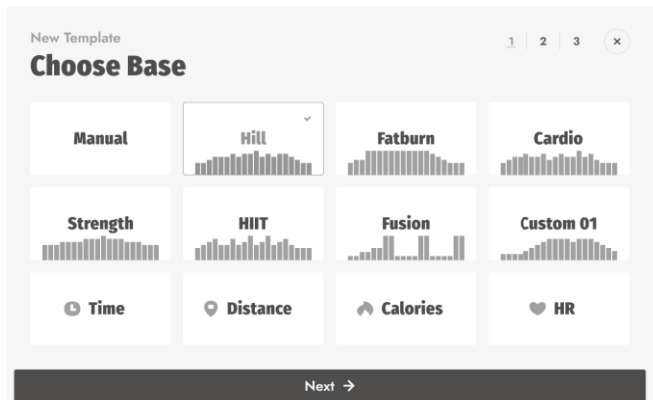
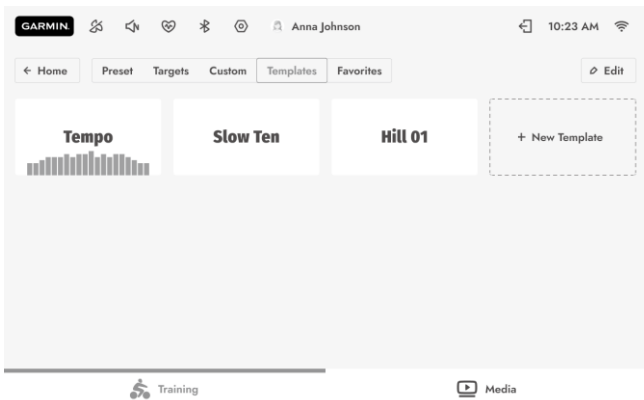

Favourites

Any program can be labelled as a Favorite. Up to 3 favourite programs will appear right on the Home screen, so you can access them more easily. To “like” a program, open the program setup page and tap on the “ribbon” icon in the upper left corner of the screen. You can find all of the labelled programs under the Favorites tab: to remove the label, press “Edit”, or go to the program setup page directly and un-tap the “ribbon” icon.

Once you have decided on the program, press the “Start This Program” button on the screen, or the physical “START” key on the machine to begin your workout.

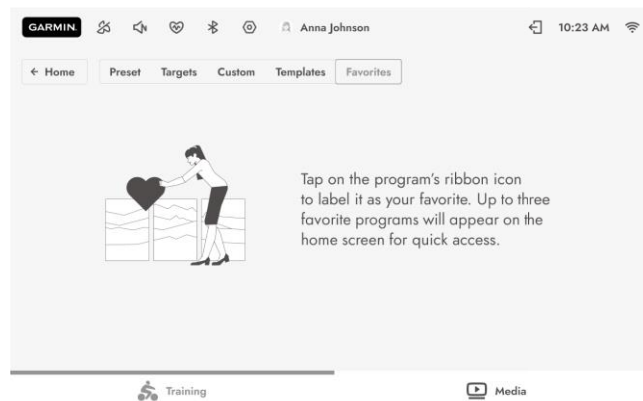

History

To see your latest workout records, press “History” on the main screen of the Training section. Up to 10 records can be stored locally on the console, but you can access your full workout history if you link your profile to the SPIRIT+ mobile app. Tap on the record preview to see the full summary. Each user can only see his or her workouts.

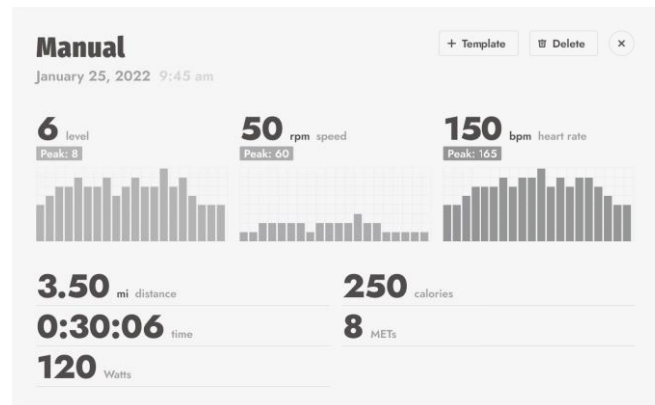
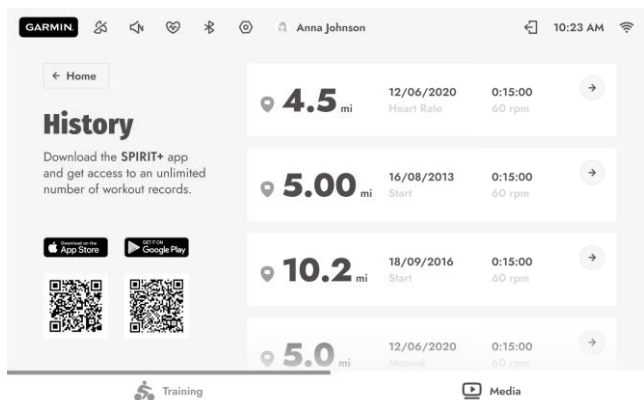

HEART RATE EXERTION

The old motto, “no pain, no gain”, is a myth that has been overpowered by the benefits of exercising comfortably. A great deal of this success has been promoted by the use of heart rate monitors. With the proper use of a heart rate monitor, many people find that their usual choice of exercise intensity was either too high or too low and exercise is much more enjoyable by maintaining their heart rate in the desired benefit range.

To determine the benefit range in which you wish to train, you must first determine your Maximum Heart Rate. This can be accomplished by using the following formula: 220 minus your age. This will give you the Maximum Heart Rate (MHR) for someone of your age. To determine the effective heart rate range for specific goals you simply calculate a percentage of your MHR. Your Heart rate training zone is 50% to 90% of your maximum heart rate. 60% of your MHR is the zone that burns fat while 80% is for strengthening the cardiovascular system. This 60% to 80% is the zone to stay in for maximum benefit.

For someone who is 40 years old, their target heart rate zone is calculated:

$220 - 40 = 180$ (maximum heart rate)
 $180 \times .6 = 108$ beats per minute
(60% of maximum)
 $180 \times .8 = 144$ beats per minute
(80% of maximum)

So, for a 40-year-old, the training zone would be 108 to 144 beats per minute.

If you enter your age during programming the console will perform this calculation automatically. Entering your age is used for the Heart Rate programs. After calculating your MHR you can decide upon which goal you would like to pursue.

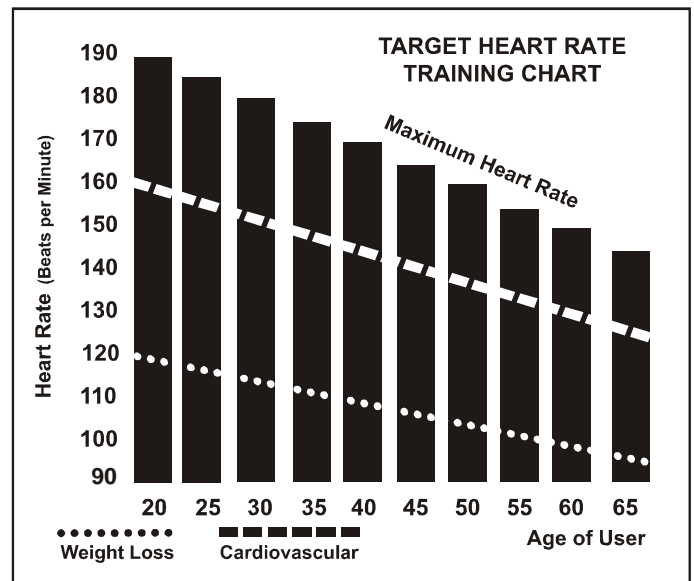

The two most popular reasons for, or goals, of exercise, are cardiovascular fitness (training for the heart and lungs) and weight control. The black columns on the chart above represent the MHR for a person whose age is listed at the bottom of each column. The training heart rate, for either cardiovascular fitness or weight loss, is represented by two different lines that cut diagonally through the chart. A definition of the lines' goal is in the bottom left-hand corner of the chart. If your goal is cardiovascular fitness or if it is weight loss, it can be achieved by training at 80% or 60% respectively, of your MHR on a schedule approved by your physician. Consult your physician before participating in any exercise program.

With all Heart Rate program treadmills, you may use the heart rate monitor feature without using the Heart Rate program. This function can be used during manual mode or any of the nine different programs. The Heart Rate program automatically controls incline.

HEART RATE - PERCEIVED EXERTION

Heart rate is important but listening to your body also has a lot of advantages. There are more variables involved in how hard you should work out than just heart rate. Your stress level, physical health, emotional health, temperature, humidity, the time of day, the last time you ate and what you ate, all contribute to the intensity at which you should workout. If you listen to your body, it will tell you all of these things.

The rate of perceived exertion (RPE), also known as the Borg scale, was developed by Swedish physiologist G.A.V. Borg. This scale rates exercise intensity from 6 to 20 depending upon how you feel or the perception of your effort.

The scale is as follows:

Rating Perception of Effort

- 6 Minimal
- 7 Very, very light
- 8 Very, very light +
- 9 Very light
- 10 Very light +
- 11 Fairly light
- 12 Comfortable
- 13 Somewhat hard
- 14 Somewhat hard +
- 15 Hard
- 16 Hard +
- 17 Very hard
- 18 Very hard +
- 19 Very, very hard
- 20 Maximal

You can get an approximate heart rate level for each rating by simply adding a zero to each rating. For example, a rating of 12 will result in an approximate heart rate of 120 beats per minute. Your RPE will vary depending on the factors discussed earlier. That is the major benefit of this type of training. If your body is strong and rested, you will feel strong and your pace will feel easier. When your body is in this condition, you can train harder and the RPE will support this. If you are feeling tired and sluggish, it is because your body needs a break. In this condition, your pace will feel harder. Again, this will show up in your RPE and you will train at the proper level for that day.

USING HEART RATE TRANSMITTER (OPTIONAL)

How to wear your wireless chest strap transmitter:

1. Attach the transmitter to the elastic strap using the locking parts.
2. Adjust the strap as tightly as possible as long as the strap is not too tight to remain comfortable.
3. Position the transmitter with the logo centered in the middle of your torso facing away from your chest (some people must position the transmitter slightly left of center). Attach the end of the elastic strap by inserting the round end and, using the locking parts, secure the transmitter and strap around your chest.
4. Position the transmitter directly below the pectoral muscles.
5. Sweat is the best conductor to measure very minute heartbeat electrical signals. However, plain water can also be used to pre-wet the electrodes (2 ribbed oval areas on the reverse side of the belt and both sides of the transmitter). It's also recommended that you wear the transmitter strap a few minutes before your workout. Some users, because of body chemistry, have a more difficult time achieving a strong, steady signal at the beginning. After "warming up", this problem lessens. As noted, wearing clothing over the transmitter/strap doesn't affect performance.
6. Your workout must be within range - distance between transmitter/receiver – to achieve a strong steady signal. The length of the range may vary somewhat but generally stay close enough to the console to maintain good, strong, reliable readings. Wearing the transmitter directly on bare skin assures you of proper operation. If you wish, you may wear the transmitter over a shirt. To do so, wet the areas of the shirt that the electrodes will rest upon.

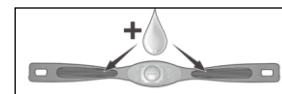
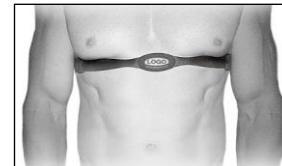

Note: The transmitter is automatically activated when it detects activity from the user's heart. Additionally, it automatically deactivates when it does not receive any activity. Although the transmitter is water resistant, moisture can have the effect of creating false signals, so you should take precautions to completely dry the transmitter after use to prolong battery life (estimated transmitter battery life is 2500 hours). The replacement battery is Panasonic CR2032.

Erratic Operation

Caution! Do not use this Recumbent Bike for Heart Rate programs unless a steady, solid Actual Heart Rate value is being displayed. High, wild, random numbers being displayed indicate a problem.

Areas to look for interference which may cause erratic heart rate:

1. Microwave ovens, TVs, small appliances, etc.
 2. Fluorescent lights.
 3. Some household security systems.
 4. Perimeter fence for a pet.
 5. Some people have problems with the transmitter picking up a signal from their skin. If you have problems, try wearing the transmitter upside down. Normally the transmitter will be oriented, so the Spirit Fitness logo is right side up.
 6. The antenna that picks up your heart rate is very sensitive. If there is an outside noise source, turning the whole machine 90 degrees may de-tune the interference.
 7. Another Individual wearing a transmitter within 3' of your machine's console.
- If you continue to experience problems, contact your dealer.

MAINTENANCE & CARE

POST-WORKOUT MACHINE CARE

1. Store your machine according to the folding instructions when not in use.
2. Use a slightly damp cloth to clean areas where sweat or oil made contact with the machine.
3. Use a microfiber cloth to clean the touchscreen and remove unwanted oils and other things that may damage the screen.
4. Avoid leaving paper or other small debris in the cupholders.

SANITIZING YOUR FITNESS EQUIPMENT

- Unupholstered high-contact surfaces (hard plastics) can be sanitized using a 75% isopropyl alcohol solution and a clean, dry cloth. Spray surfaces to be sanitized and use a dry cloth to wipe clean. Allow surfaces to dry before using.
- For upholstered or soft-plastic surfaces, use a conditioner after sanitizing. Be sure to follow the instructions provided by the conditioner manufacturer to ensure proper use of the conditioner.
- Alternatively, you can make your spray by mixing the proper ratio of isopropyl alcohol and distilled water to reach a 75% solution.

TROUBLESHOOTING

Problem	Solution/Cause
The display does not light	<ol style="list-style-type: none"> 1. Plug is disconnected. Make sure the plug is firmly pushed into the 115VAC wall outlet and the cycle. 2. Bike defect. Contact your dealer.
Squeak, thump, and clicking sounds heard	<ol style="list-style-type: none"> 1. The hardware was not sufficiently tightened during assembly. All bolts that were installed during assembly need to be tightened as much as possible. It may be necessary to use a larger wrench than the one provided if you cannot tighten the bolts sufficiently. 90%of calls to the service department for noise issues can be traced to loose hardware. 2. The crank arm nut needs to be retightened. 3. If squeaks or other noises persist, check that the unit is properly levelled. There are 2 levelling pads on the bottom of the rear stabilizer, use a 14mm wrench (or adjustable wrench) to adjust the levellers.
The rough feeling when using the bike	<ol style="list-style-type: none"> 1. The hardware was not sufficiently tightened during assembly. All bolts that were installed during assembly need to be tightened as much as possible. It may be necessary to use a larger wrench than the one provided if you cannot tighten the bolts sufficiently. 90% of calls to the service department for noise issues can be traced to loose hardware. 2. The crank arm nut needs to be retightened. 3. If squeaks or other noises persist, check that the unit is properly levelled. There are 2 levelling pads on the bottom of the rear stabilizer, use a 14mm wrench (or adjustable wrench) to adjust the levellers.

PARTS LIST

Key	Part Description	Q'ty
1	Main Frame	1
2	Console Mast	1
3	Mast Handlebar Assembly	1
4	Seat Carriage	1
5	Seat Back Frame	1
6	Seat Handlebar	1
7	Rear Stabilizer	1
8	Crank Axle	1
9L	Seat Wheel Adjustment Plate (L)	2
9R	Seat Wheel Adjustment Plate (R)	2
10	Idler Wheel Assembly	1
11	Seat Stop Axle	2
12	Seat Position Latch	1
13	Backing Plate	3
14	Aluminum Track	1
15	Rack	1
16	Spacer for Stopper Axle	4
17	Rubber Foot	4
18	Transportation Wheel	2
19	Console Assembly	1
20	Drive Pulley	1
24	Button Head Plug	2
25	Seat Track Wheel	8
26	300mm_Hand Pulse Sensor Assembly W/Cable	1
26-1	300mm_Hand Pulse Sensor Assembly W/Cable (White)	1
27	750mm_Handpulse W/Cable Assembly(L)	1
27-1	950mm_Handpulse W/Cable Assembly(R)	1
28	Crank Arm End Cap	2
29	Front Shroud (L)	1
30	Front Shroud (R)	1
31	Console Mast Cover	1
32	Handgrip End Cap	4
33	Bottom Cover	1
34	Round Disk Cover	2
35	Rear Shroud (L)	1
36	Rear Shroud (R)	1
38	Handgrip (L.R)	1
39	Drink Bottle Holder	1
40	Release Lever	1
41	Transformer Power Cord	1
43	Gear Motor	1
44	750mm_Computer Cable	1
45	2100mm_Hand Pulse Sensor Assembly W/Cable	1
46	250mm_Sensor W/Cable	1
48	750mm_DC Power Cord	1

Key	Part Description	Q'ty
51L	Crank Arm(L)	1
51R	Crank Arm(R)	1
52	6004_Bearing	2
53	6203_Bearing	2
54	Drive Belt	1
55	Flywheel	1
56	Magnet	1
57	Gas Cylinder	1
58	Steel Cable	1
61	Seat	1
62	Steel Cable	1
63	Mesh Seat Back	1
64	Handgrip Foam	2
65	3/8" x 53mm_Carriage Bolt	2
66	1/4" x 3/4" _Hex Head Bolt	4
67	3/8" x UNC16 x 4" _Hex Head Bolt	2
68	5/16" x UNC18 x 5/8" _Hex Head Bolt	17
69	5/16" x 2- 1/2" _Hex Head Bolt	1
70	5/16" x UNC18 x 1-1/4" _Hex Head Bolt	1
71	3/8" x 1-3/4" _Hex Head Bolt	4
72	Ø1/4" x 13 x 1T _Flat Washer	5
73	Ø1/4" x 19 x 1.5T _Flat Washer	4
75	Ø17 x Ø23.5 x 1T _Flat Washer	1
76	Ø5/16" x Ø18 x 1.5T _Flat Washer	18
77	Ø3/8" x Ø19 x 1.5T _Flat Washer	5
79	Ø8 x Ø18 x 3T _Knurled Lock Washer	4
81	3/8" x 3/4" _Button Head Socket Bolt	1
82	5/16" x 1.5T _Split Washer	9
83	5/16" x 19 x 1.5T _Curved Washer	2
84	Ø3/8" x Ø25 x 2T _Flat Washer	2
85	Ø17_C Ring	1
86	Ø20_C Ring	2
87	M8 x 130mm _J Bolt	1
88	M8 x 7T _Nylon Nut	5
89	3/8" x 7T _Nylon Nut	7
90	1/4" x 8T _Nylon Nut	4
91	5/16" x 6T _Nylon Nut	7
93	M6 x 38mm _Socket Head Cap Bolt	1
94	5/16" x UNC18 x 3/4" _Hex Head Bolt	6
95	M5 x 12mm _Flat Head Socket Screw	10
97	3 x 20mm _Tapping Screw	4
98	M6 x 15mm _Phillips Head Screw	8
99	M5 x 12mm _Phillips Head Screw	20
101	Ø5 x 16mm _Tapping Screw	11
103	3.5 x 16mm _Sheet Metal Screw	12
104	Spring	1

Key	Part Description	Q'ty
106	5/16" x UNC18 x 1-3/4" _Button Head Socket Bolt	2
108	M10 x P1.25 x 10T _Nut	2
111	M5 x P0.8 x 10L _Flat Phillips Head Screw	8
112	12/14mm _Wrench	1
113	13/15mm _Wrench	1
114	Phillips Head Screwdriver	1
115	L Allen Wrench	1
116	Pedal (L.R)	1
119	3/8"-UNF26 x 3T _Nut	2
121	3/8"-UNF26 x 7T _Nut	2
125	Seat Carriage Cover	1
126	HGP Wire Grommet	1
129	M6 x 6T _Nylon Nut	1
130	13/14mm _Wrench	1
131	Power Adaptor	1
140	Sensor Rack	1
141	Handlebar Cover	1
143	Seat Track Fixing Plate	1
144	Handgrip End Cap	2
145	Resistance Button W/Cable	2
146	Handgrip Resistance Label (UP)	1
147	Handgrip Resistance Label (DOWN)	1
148	2100mm _Switch Cable (Upper)	1
149	300mm _Handle Switch Bracket	1
150	180mm _Handlebar Resistance Cable	1
151	Switch Cable (Lower)	1
153	Console Holder Assembly	1
154	5/16" x 2-1/2" _Hex Head Bolt	1
155	Tablet Holder Assembly	1
156	2.3 x 6mm _Sheet Metal Screw	2
157	Pad	1
158	Rotate Axle Bracket	1
160	Ø5/16" x 16 x 1.5T _Flat Washer	8
161	M6 x 10L _Flat Phillips Head Screw	4
162	Ø1/4" x Ø16 x 1.0T _Flat Washer	4
163	Sleeve	4
164	M6 x 19L _Nut	4
165	M6 x 10L _Button Head Socket Bolt	4
166	PU Wheel	4
167	Seat Front/Aft Adjustment Lever	1
168	Lever Anchor	1
169	M5 x 25mm _Flat Head Socket Screw	2
170	Ø15 x Ø6 x 4T _Nylon Washer	1
171	M5 x 45mm _Socket Head Cap Bolt	1
172	Ø5 x Ø10 x 1.0T _Flat Washer	1
173	M5 x 5T _Nylon Nut	2
177	Rubber Foot Pad	1

Key	Part Description	Q'ty
183	Locking Plate	2
184	Flat Washer	2
185	3/8" x 4T_Nut	1
186	ChenChin Torsion-Spring	1
187	M5 x 20L_Phillips Head Screw	1
188	5/16" x UNC18 x 1-1/2" _Hex Head Bolt	1
189	Rubber Pad	2
190	Tablet Holder Front Cover	1
190-1	Tablet Holder Rear Cover	1
190-2	Tablet Holder Top clip	1
190-3	Tablet Holder Bottom clip	1
190-4	Spring	2
190-5	Spring column	2
191	3/8" x UNC16 x 12.5T_Cap Nut	2
192	3.5 x 12mm_Sheet Metal Screw	7
204	M6 x P1.0 x 12L_Socket Head Cap Bolt	4
245	M8 x 30mm_Flat Head Socket Screw	6
246	M8 x 1.25 x 6.5T_Square Nut	6

MANUFACTURER'S LIMITED WARRANTY

Dyaco Canada Inc. warrants all its bike parts for the period of time listed below, from the date of retail sale, as determined by a sales receipt. Dyaco Canada Inc.'s responsibilities include providing new or remanufactured parts at Dyaco Canada Inc.'s option and technical support to our independent dealers and service organizations. In the absence of a dealer or service organization, these warranties will be administered by Dyaco Canada Inc. directly to a consumer. The warranty period applies to the following components:

Home Warranty

Frame	Lifetime
Flywheel	Lifetime
Parts	10 Years
Console	2 Years
Labour	1 Year

This warranty is not transferable and is extended only to the original owner.

The warranty shall not apply to exercise units that are (1) used for commercial or other income-producing purposes or (2) subject to misuse, neglect, accident or unauthorized repair and alterations.

This warranty provided herein is in lieu of all other express warranties; any implied warranties, including any implied warranties of merchantability of fitness for a particular purpose, are limited in duration to the first 12 months from the date of purchase. All other obligations or liabilities, including liability for consequential damages, are hereby excluded.

REPAIR PARTS AND SERVICE

All of the parts for the Spirit cycle shown in the figure can be ordered from Dyaco Canada Inc. 5955 Don Murie Street, Niagara Falls, Ontario L2G 0A9. When ordering parts, the parts will be sent and billed at the current prices. Prices may be subject to change without notice.

Check, or money order must accompany all orders. Standard hardware items are available at your local hardware store.

To ensure prompt and correct handling of any errors, or to answer any questions, please call our Toll Free number: 1-888-707-1880, or local number 1-905-353-8955 or fax 1-905-353-8968, email customerservice@dyaco.ca or visit our website at www.dyaco.ca. Office hours are from 8:30 AM to 5:00 PM Monday to Friday Eastern Standard Time.

Always include the following information when ordering parts

- Model number
- Name of each part
- Part number of each part

dyaco

Please visit us online for information about our other brands and products manufactured and distributed by Dyaco Canada Inc.

SPIRIT

spiritfitness.ca

**X TERRA
FITNESS**

xterrafitness.ca

UFC

dyaco.ca/UFC/UFC-home.html

agio.
life begins
outdoors.

agiocanada.ca

SOLE
FITNESS

solefitness.ca

EVERLAST

dyaco.ca/everlast.html

Cikada

cikada.ca

**TRINOR
SPORTS**

trainorsports.ca

For more information, please contact Dyaco Canada Inc.
T: 1-888-707-1880 | 5955 Don Murie St., Niagara Falls, Ontario L2G 0A9 | sales@dyaco.ca

Dyaco Canada Inc. dyaco.ca