

Owner's Manual

Model No.
16007408500
CT850

- Assembly
- Operation
- Adjustments
- Parts
- Warranty

CAUTION:

Read and understand this manual before operating unit

SPIRIT



**Retain For Future
Reference**

TABLE OF CONTENTS

Product Registration	3
Important Safety Instructions.....	5
Important Electrical Instructions	6
Important Operation Instructions	7
Assembly Instructions	9
Operation of Your New Treadmill	16
Programmable Features	18
Using a Heart Rate Transmitter.....	32
Exploded View Diagram.....	33
Parts List.....	34
General Maintenance.....	37
Service Checklist – Diagnosis Guide.....	41
Manufacturer's Limited Warranty.....	48

Thank you for purchasing our product. Please save these instructions. Please do not perform or attempt any customizing, adjustments, repair or maintenance that is not described in this manual.

SPIRIT

**CONGRATULATIONS ON YOUR
NEW TREADMILL AND WELCOME
TO THE SPIRIT FAMILY!**

Thank you for your purchase of this quality treadmill from Dyaco Canada Inc. Your new treadmill was manufactured by one of the leading fitness manufacturers in the world and is backed by one of the most comprehensive warranties available. Through your dealer, Dyaco Canada Inc. will do all we can to make your ownership experience as pleasant as possible for many years to come. The local dealership where you purchased this treadmill is your administrator for all warranty and service needs. Their responsibility is to provide you with the technical knowledge and service personnel to make your experience more informed and any difficulties easier to remedy.

Please take a moment at this time to record the name of the dealer, their telephone number, and the date of purchase below to make any future needed contact easy. We appreciate your support, and we will always remember that you are the reason that we are in business.

Please go to www.dyaco.ca/warranty.html and complete the online warranty registration.

Yours in Health,
Dyaco Canada Inc.

Name of Dealer _____

Telephone Number of Dealer _____

Purchase Date _____

Product Registration

RECORD YOUR SERIAL NUMBER

Please record the Serial Number of this fitness product in the space provided below.

Serial Number _____

REGISTER YOUR PURCHASE

Please visit us at www.dyaco.ca/warranty.html to register your purchase.

BEFORE YOU BEGIN

Thank you for choosing the SPIRIT CT850 Treadmill. We take great pride in producing this quality product and hope it will provide many hours of quality exercise to make you feel better, look better, and enjoy life to its fullest. It's a proven fact that a regular exercise program can improve your physical and mental health. Too often, our busy lifestyles limit our time and opportunity to exercise. The SPIRIT CT850 Treadmill provides a convenient and simple method to begin your assault on getting your body in shape and achieving a happier and healthier lifestyle. Before reading further, please review the drawing below and familiarize yourself with the parts that are labelled.

Read this manual carefully before using the SPIRIT CT850 Treadmill. Although Dyaco Canada Inc. constructs its products with the finest materials and uses the highest standards of manufacturing and quality control, there can sometimes be missing parts or incorrectly sized parts. If you have any questions or problems with the parts included with your SPIRIT CT850 Treadmill, please do not return the product. Contact us **FIRST!** If a part is missing or defective, call us toll-free at 1-888-707-1880. Our Customer Service Staff are available to assist you from 8:30 A.M. to 5:00 P.M. (Eastern Time) Monday through Friday. Be sure to have the name and model number of the product available when you contact us.



MAX. USER WEIGHT LIMIT 204 KGS (450 LBS)

IMPORTANT SAFETY INSTRUCTIONS

WARNING - Read all instructions before using this equipment.

DANGER - To reduce the risk of electric shock, always unplug this treadmill from the electrical outlet prior to cleaning and/or service work.

WARNING - To reduce the risk of burns, fire, electric shock, or injury to persons, install the treadmill on a flat level surface with access to a 120-volt, 20-amp grounded outlet.

WARNING - Heart rate monitoring systems may be inaccurate. Over-exercising may result in serious injury or death. If you feel faint, stop exercising immediately.

The treadmill should be the only equipment in the circuit to which it is connected. **DO NOT ATTEMPT TO DISABLE THE GROUNDED PLUG BY USING IMPROPER ADAPTERS OR IN ANY WAY MODIFY THE CORD SET.** A serious shock or fire hazard may result along with computer malfunctions.

ASTM F2115-05 Specifications 6.1.2.11 The recommended minimum clearance required around each treadmill for access to, passage around, and emergency dismount shall be stated. The minimum dimensions are to be: 0.5 m (19.7 in.) on each side of the treadmill and 1 m (39 in.) behind the machine.

- Do not operate the treadmill on deeply padded, plush or shag carpet. Damage to both carpet and treadmill may result.
- Keep children under the age of 13 away from the treadmill. There are obvious pinch points and other caution areas that can cause harm.
- Keep hands away from all moving parts.
- Never operate the treadmill if it has a damaged cord or plug. If the treadmill is not working properly, call your dealer.
- Keep the cord away from heated surfaces.
- Do not operate where aerosol spray products are being used or where oxygen is being administered. Sparks from the motor may ignite a highly gaseous environment.
- Never drop or insert any object into any openings.
- Do not use outdoors.
- To disconnect, turn all controls to the off position and then remove the plug from the outlet.
- Do not attempt to use your treadmill for any purpose other than for the purpose it is intended.
- The hand pulse sensors are not medical devices. Various factors, including the user's movement, may affect the accuracy of heart rate readings. The pulse sensors are intended only as exercise aids in determining heart rate trends in general.
- Wear proper shoes. High heels, dress shoes, sandals or bare feet are not suitable for use on your treadmill. Quality athletic shoes are recommended to avoid leg fatigue.
- Children should be supervised to ensure that they do not play with the equipment.
- Remove the tether cord after use to prevent unauthorized treadmill operation.
- Connect this treadmill to a properly grounded outlet only. See Grounding Instructions.
- Please make sure that the power supply cord and adapter are placed in a dry area and kept away from heat
- This exercise equipment is not intended for use by persons with reduced physical, sensory or mental capabilities or lack of experience and knowledge.
- Before beginning, this or any exercise program, consult a physician. This is especially important for persons over the age of 35 or persons with pre-existing health conditions.
- Close supervision is necessary when this exercise equipment is used by, on, or near children, invalids, or disabled persons.

User weight should not exceed 450 lbs (204 kgs).

SAVE THESE INSTRUCTIONS - THINK SAFETY!

IMPORTANT ELECTRICAL INSTRUCTIONS

WARNING!

NEVER use an RCD - Residual Current Device (U.S. ver.= GFCI) - wall outlet with this treadmill. As with any equipment with a large motor, the RCD/GFCI will trip often. Route the power main cord away from any moving part of the treadmill, including the elevation mechanism and transport wheels.

NEVER remove any cover without first disconnecting AC power. If voltage varies by ten percent (10%) or more, the performance of your treadmill may be affected. **Such conditions are not covered under your warranty.** If you suspect the voltage is low, contact your local power company or a licensed electrician for proper testing.

NEVER expose this treadmill to rain or moisture. This product is **NOT** designed for use outdoors, near a pool or spa, or in any other high-humidity environment. The temperature specification is 40 degrees c, and humidity is 95%, non-condensing (no water drops forming on surfaces).

Circuit breakers: Avoid AFCI/GFCI circuit breakers if possible. These breakers may occasionally trip during use because of the high inrush currents from the treadmill drive motor. This condition is an issue with all treadmills and other products with large motors or electric heating elements like ovens. New laws in your area may require these breakers. If you do have these breakers and outlets in your home and are experiencing nuisance tripping, you should check to see if there are any other devices plugged into the same circuit like fluorescent lights with electronic ballasts, coffee makers, space heaters, etc. Optimally the treadmill should be the only device plugged into the circuit.

Our treadmills have surge suppressors built in to help avoid nuisance tripping. We have tested several AFCI/GFCI breakers and outlets with our products that do not trip when only the treadmill is connected. Brands we have tested are Eaton (Cutler-Hammer Series), Leviton (Smart lock pro) and Schneider Electric (Canadian home series).

GROUNDING INSTRUCTIONS

This product must be grounded. If the treadmill's electrical system should malfunction or break down grounding provides a path of least resistance for electric current, reducing the risk of electric shock. This product is equipped with a cord having an equipment-grounding plug. The plug must be plugged into an appropriate outlet that is properly installed and grounded in accordance with all local codes and ordinances.

DANGER - Improper connection of the equipment-grounding conductor can result in a risk of electric shock. Check with a qualified electrician or serviceman if you are in doubt as to whether the product is properly grounded. Do not modify the plug provided with the product if it will not fit the outlet; have a proper outlet installed by a qualified electrician.

This product is for use on a nominal 120-volt circuit and has a grounding plug that looks like the plug illustrated below. The use of this treadmill requires a NEMA 5-20 receptacle installed by a licensed electrician to ensure safety.

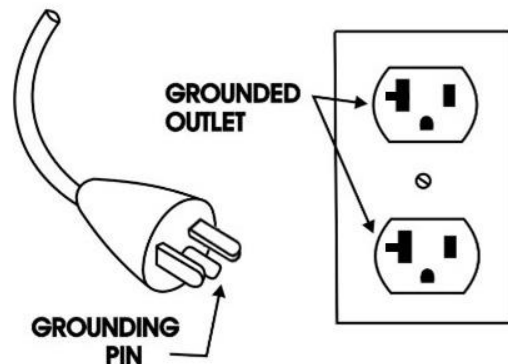

IMPORTANT OPERATION INSTRUCTIONS

- **NEVER** operate this treadmill without reading and completely understanding the results of any operational change you request from the computer console.
- Understand that changes in speed and incline do not occur immediately. Set your desired speed on the computer console and release the adjustment key. The computer will obey the command gradually.
- **NEVER** use your treadmill during an electrical storm. Surges may occur that could damage treadmill components.
- Use caution while participating in other activities while walking on your treadmill, such as watching television, reading, etc. These distractions may cause you to lose balance or stray from walking in the center of the belt, which may result in serious injury.
- **NEVER** mount or dismount the treadmill while the belt is moving. Treadmills start at a very low speed, and it is unnecessary to straddle the belt during startup. Simply standing on the belt during slow acceleration is proper after you have learned to operate the unit.
- Always hold on to a handrail or handle while making control changes (incline, speed, etc.).
- Do not use excessive pressure on console control keys. They are precision set to function properly with little finger pressure. Pushing harder is not going to make the unit go faster or slower. If you feel the buttons are not functioning properly with normal pressure, contact your dealer.

SAFETY TETHER CORD

A safety tether cord is provided with this unit. It is a simple pin design that should be used at all times. It is for your safety should you fall or move too far back on the tread-belt. Pulling this safety tether cord will stop tread-belt movement.

To Use:

1. Place the pin into position on the round-slotted metal portion of the console control head. Your treadmill will not start and operate without this. Removing the pin also secures the treadmill from unauthorized use.
2. Fasten the plastic clip onto your clothing securely to ensure good holding power. Note: The pin has a strong enough connection to minimize accidental, unexpected stopping. The clip should be attached securely to make certain it does not come off. Be familiar with its function and limitations. The treadmill will stop, depending on speed, with a one to two-step coast anytime the pin is pulled out of the console. Use the red Stop/Pause switch in normal operation

WARNING DECAL REPLACEMENT

The decal shown below has been placed on the treadmill. If the decal is missing or illegible, please call our Customer Service Department toll-free at 1-888-707-1880 to order a replacement decal.

! WARNING / AVERTISSEMENT

Model/Modèle#: [REDACTED]
Serial#/Numéro de série: [REDACTED]

**For consumer use only.
Max user weight limit**
[REDACTED]

CAUTION: SMALL CHILDREN AND PERSONS PHYSICALLY HANDICAPPED SHOULD NOT USE ANY EXERCISE EQUIPMENT WITHOUT A QUALIFIED PERSON IN ATTENDANCE.
WARNING: KEEP CHILDREN AWAY FROM THE [REDACTED].
KEEP BODY AND CLOTHING FREE AND CLEAR OF ALL MOVING PARTS. THE POSSIBILITY OF SERIOUS INJURIES OR DEATH IF CAUTION IS NOT USED.
READ ALL WARNINGS AND INSTRUCTIONS PRIOR TO USE. REPLACE LABEL IF DAMAGED, ILLEGIBLE OR REMOVED.

[REDACTED]

**Usage à des fins personnelles seulement
poids maximum de l'utilisateur**
[REDACTED]

ATTENTION: LES ENFANTS ET LES PERSONNES AYANT UN HANDICAP PHYSIQUE NE DOIVENT UTILISER AUCUN APPAREIL D'EXERCICE SANS LA SURVEILLANCE D'UNE PERSONNE QUALIFIÉE.
AVERTISSEMENT: GARDER LES ENFANTS À L'ÉCART DU [REDACTED]. GARDER LE CORPS ET LES VÊTEMENTS ÉLOIGNÉS DE TOUTE PIÈCE MOBILE. LE DÉFAUT DE VIGILANCE DANS L'UTILISATION DE CET APPAREIL POURRAIT ENTRAÎNER DE GRAVES BLESSURES ET MÊME LA MORT.
LIRE TOUS LES AVERTISSEMENTS ET TOUTES LES DIRECTIVES AVANT UTILISATION.
REPLACER TOUTE ÉTIQUETTE ENDOMMAGÉE, ILLISIBLE OU MANQUANTE.

[REDACTED]

**Dyaco Canada Inc.
5955 Don Murie St
Niagara Falls, Ontario
L2G 0A9**

**Customer Service
Service à la clientèle
1-888-707-1880**

ASSEMBLY INSTRUCTIONS

UNPACKING

1. Cut the straps and open the box.
2. Locate the hardware package. The hardware is separated into four steps. Remove the tools first. Remove the hardware for each step as needed to avoid confusion. The numbers in the instructions that are in parenthesis (#) are the item numbers from the assembly drawing for reference.

ASSEMBLY TOOLS

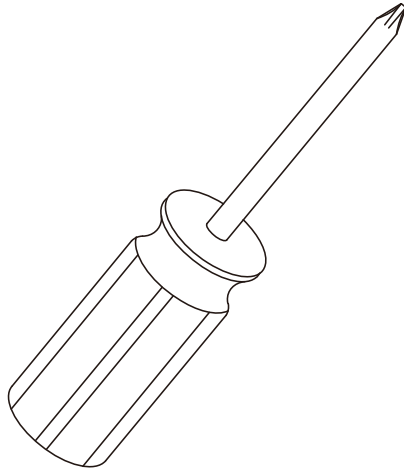

#158. Phillips Head Screwdriver (1 pc)

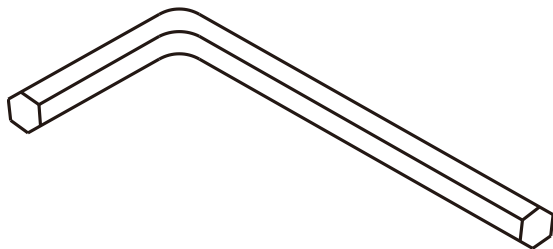

#159. 5mm L Allen Wrench (1 pc)

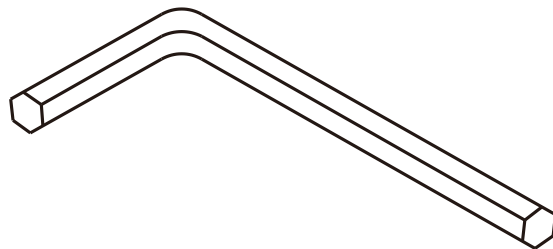

#160. 6mm L Allen Wrench (1 pc)

STEP 1

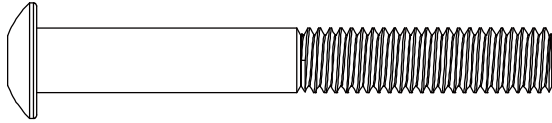

#150 - 3/8" x 3"
Button Head Socket Bolt
(10pcs)

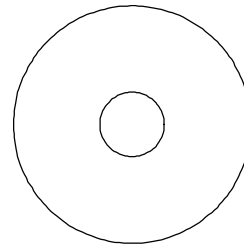

#115 - Ø3/8" x 35 x 2.0T
Flat Washer (10pcs)

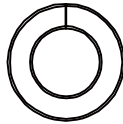

#133 - Ø10 x 2T
Split Washer (10pcs)

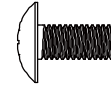

#144 - M5 x 12mm
Phillips Head Screw
(4pcs)

STEP 2

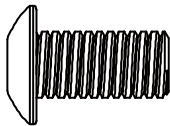

#151 - 3/8" x 3/4"
Button Head Socket Bolt
(6pcs)

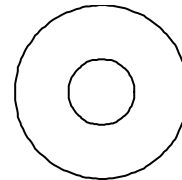

#125 - Ø3/8" x Ø25 x 2.0T
Flat Washer (6pcs)

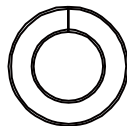

#133 - Ø10 x 2T
Split Washer (6pcs)

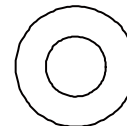

#153 - Ø8 x Ø16 x 2T
Flat Washer (5pcs)

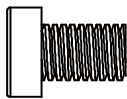

#152 - M8 x 12mm
Socket Head Cap Bolt
(5pcs)

STEP 3

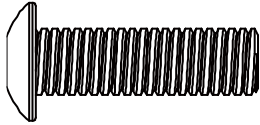

#154 - 3/8" x 1-1/4"
Button Head Socket Bolt
(2pcs)

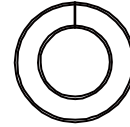

#133 - Ø10 x 2T
Split Washer (2pcs)

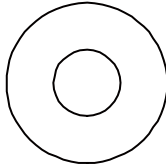

#155 - Ø10 x Ø23 x 1.5T
Curved Washer (2pcs)

STEP 4

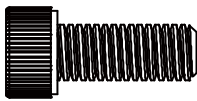

#156 - M8 x 20L
Socket Head Cap Bolt
(4pcs)

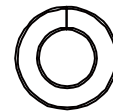

#120 - Ø8 x 1.5T
Split Washer (4pcs)

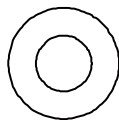

#153 - Ø8 x Ø16 x 2T
Flat Washer (4pcs)

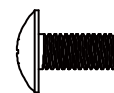

#144 - M5 x 12mm
Phillips Head Screw
(2pcs)

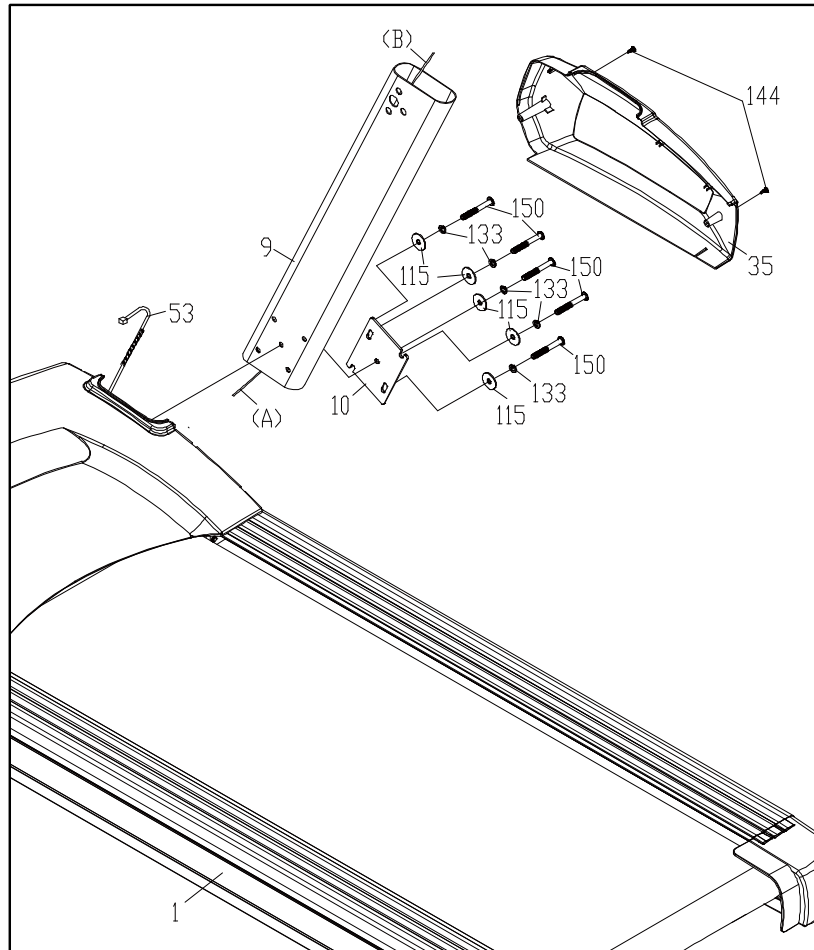

STEP 1

1. Gather Hardware for Step 1.
2. Feed the Computer Cable (No. 53) through the center of the right upright (No. 9).
3. Use four sets of Button Head Socket Bolts (No.150) and split Washer (No.133) against a Flat Washer (No.115) to secure the Upright Fixing Plate (No.10) to the Right Uprights (No.9) to the Main Frame (No.1) using the Allen Wrench (No.160).
4. Use two Phillips Head Screws (No.144) to secure the Motor Base Cap Right (No.35) to Main Frame (No.1) using the Screwdriver (No.158).
5. Repeat the previous two steps on the left side.

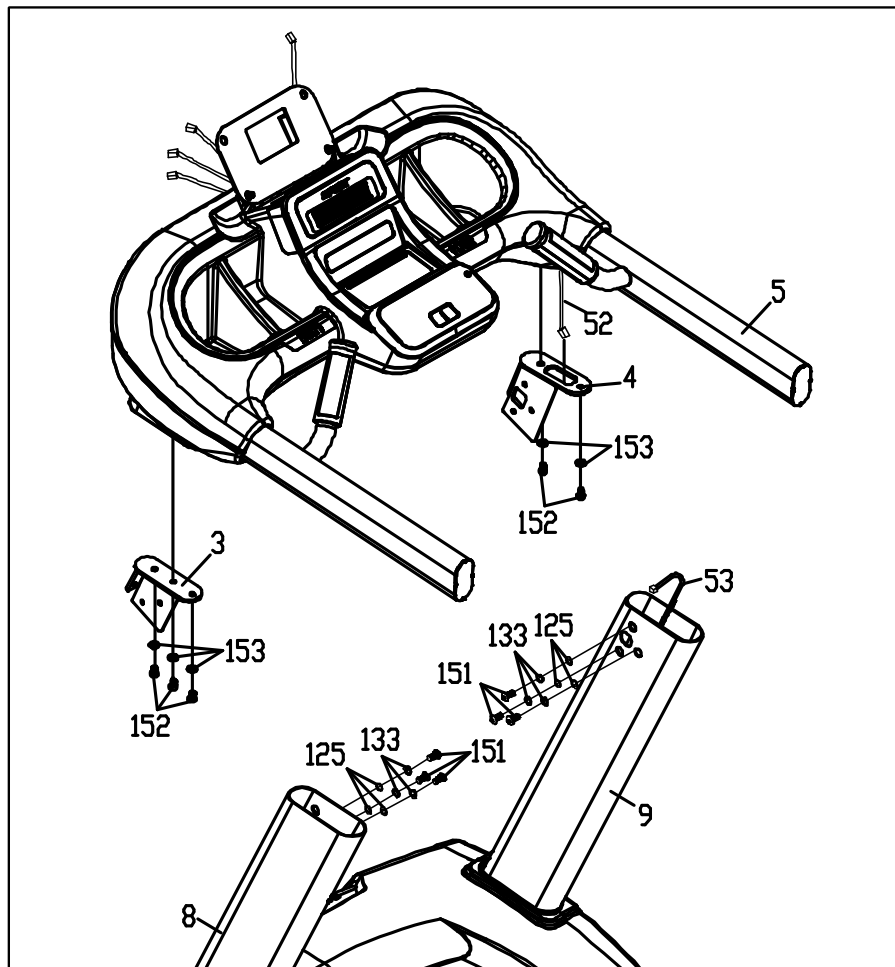

STEP 2

1. Gather Hardware for Step 2.
2. On the underside of the Console Support (No.5) is where the Locking Plate Assembly (No. 3 & 4) can be attached. Use 3 Socket Head Cap Bolts (No.152) and 3 Flat Washers (No.153) on the left side, 2 Socket Head Cap Bolts (No.152) and 2 Flat Washers (No.153) on the right side to secure.
3. Connect the Computer Cable (No. 53) with the Upper Computer Cable (No.52). Be careful not to pinch the wires and slide them into the Right Upright (No.9).
4. Gently slot the Console Support (No.5) into the Left/Right Uprights (No.8 & 9) and secure with 3 Button Head Socket Bolts (No.151), 3 Split Washers (No.133), and 3 Flat Washers (No.125) on both sides using the Allen Wrench (No.160).

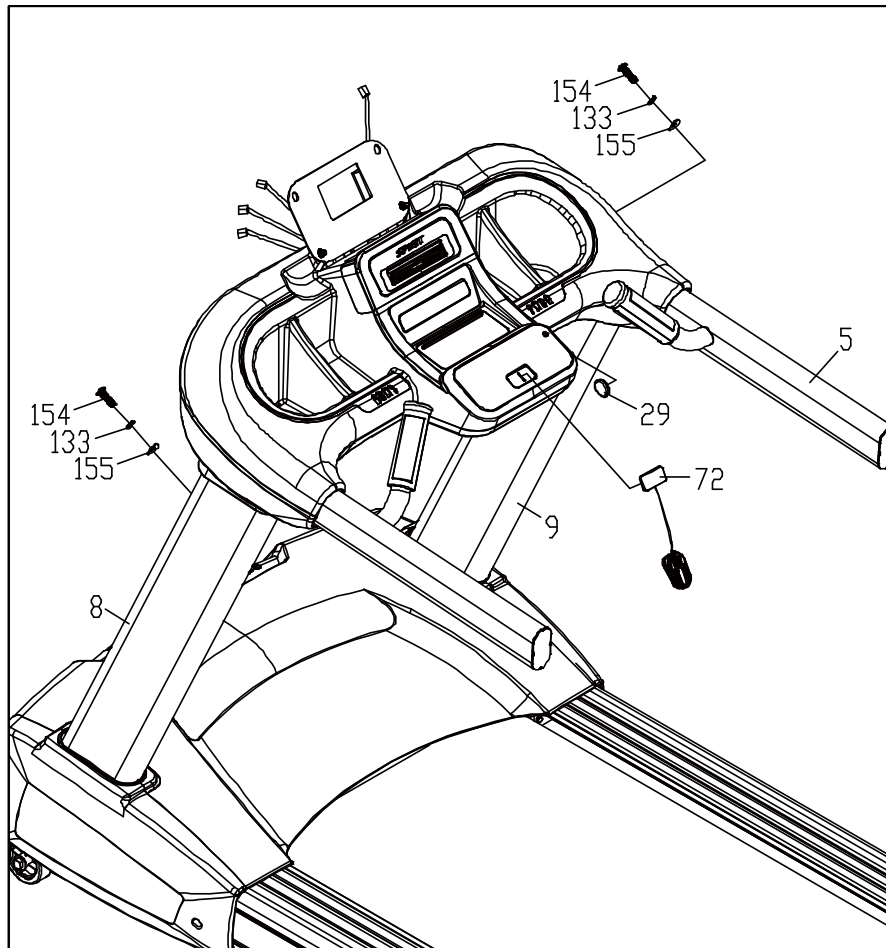

STEP 3

1. Gather Hardware For Step 3.
2. Further, secure the uprights by inserting a Button Head Socket Bolt (No.154) through a Split Washer (No.133) and a Curved Washer (No.155) onto the backside of both Left/Right Uprights (No. 8 & 9) using the Allen Wrench (No.160).
3. Plug the Round Cap (No.29) into the Right Upright (No.9).
4. Plug the Safety Key (No.72) into the Safety Key base on the Console Support (No.5).

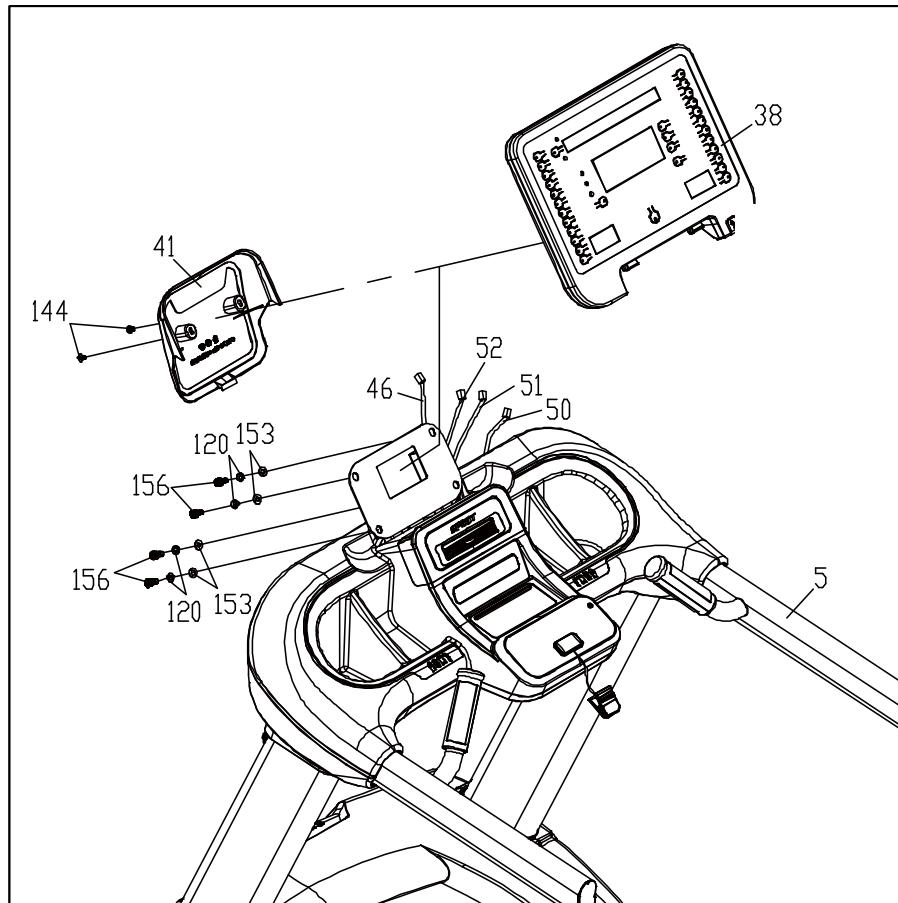

STEP 4

1. Gather Hardware for Step 4.
2. Place the Console Assembly (No.38) onto the Console Support (No.5). Secure with 4 Socket Head Cap Bolts (No.156), 4 Split Washers (No.120), and 4 Flat Washers (No.153) using the Allen Wrench (No.159).
3. Connect the Ground Wire (#46), Upper Handpulse Wires (No.50 & 51) and Upper Computer Cable (No.52) to Console Assembly (No.38).
4. Fasten the Console Cover (No.41) with 2 Phillips Head Screw (No.144) to the Console Support (No.5) using the Screwdriver (No.158).

OPERATION OF YOUR TREADMILL

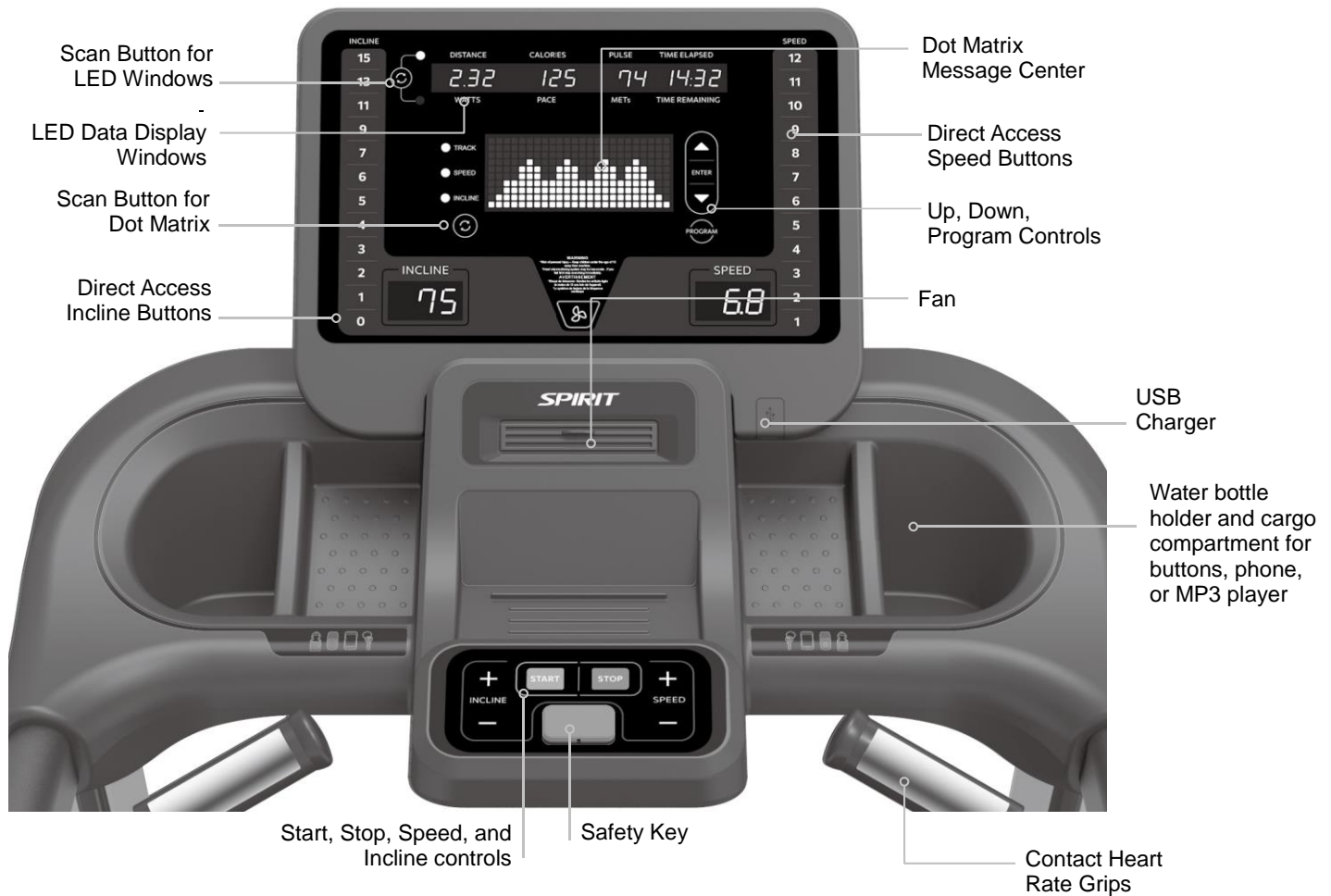

POWER

Power the treadmill on by plugging it into an appropriate wall outlet, then turn on the power switch located at the front of the treadmill below the motor hood. Ensure that the safety key is installed, as the treadmill will not power on without it.

When the power is turned on, all the lights on the display will light for a short time. Then the Time and Distance windows will display odometer readings for a short time. The Time window will show how many hours the treadmill has been in use, and the Distance window will show how many miles (or Kilometers if the treadmill is set to metric readings; see maintenance for changing settings) the treadmill has gone. A message will be displayed showing the current software version. The treadmill will then enter idle mode, which is the starting point for operation.

C-SAFE FEATURE

Your console is equipped with a C-SAFE feature. The Power (POWER) port can be used for powering a remote-controlled audio-visual system by connecting a cable from the remote to the Power port at the back of the console. The Communication port (COMM) can be used to interact with fitness software applications.

HOW TO CONNECT WITH THE BLUETOOTH:

1. During the Idle Mode, press the “Scan” button into pairing mode.
2. Please note that the default setting is for the App connection. If the user wants to change the setting for pairing with the Bluetooth chest strap, please follow the below instructions to change the default setting.
 - A. During the Idle Mode, press the “Scan” button into pairing mode.
 - B. When the message window shows “APP”, press one of Incline ▲/▼, Speed ▲/▼ or Enter ▲/▼ cycle through to the BLECHESTSTRAP function then press enter back to the Idle mode.
 - C. Then the user could connect the Bluetooth Chest Strap right away.

CONSOLE OPERATION

QUICK START

- Press and release any button to wake the display up if not already on.
- Press and release the Start button to begin belt movement at 0.5 mph/ 0.8 kph, then adjust to the desired speed using the Up/Down Speed buttons. You may also use the Direct Access Speed Buttons 1 through 12 to set to a specific speed directly.
- To slow the treadmill belt, press and hold the Speed Down button (console or handrail) to the desired speed. You may also press the Direct Access Speed Buttons, 1 through 12.
- To stop the treadmill belt, press and release the red Stop button.

PAUSE/STOP/RESET

- When the treadmill is running, the pause feature may be utilized by pressing the red Stop button once. This will slowly decelerate the treadmill belt to a stop. The incline will go to zero percent. The Time, Distance and Calorie readings will hold while the unit is in the pause mode. After 5 minutes, the display will reset and return to the start-up screen.
- To resume your exercise when in Pause mode, press the Start button. The speed and incline will return to their previous settings.
- Pressing the Stop button twice will end the program, and a workout summary will be displayed. If the Stop button is pressed a third time, the console will return to the idle mode (start-up) screen.
- If the Stop button is held down for more than 3 seconds, the console will reset.
- When you are setting data, such as age and time, for a program pressing the Stop button will allow you to go back one step for each button press.

INCLINE

- The incline may be adjusted anytime after the belt starts moving.
- Press and hold the adjust Incline Up/Down buttons to achieve the desired level of effort. You may also choose a more rapid increase/decrease by selecting a rapid incline button, 1 through 15, on the left-hand side of the console (incline).
- The display will indicate incline numbers as a percentage of grade (the same as the grade of a road) as adjustments are made.

DOT MATRIX CENTER DISPLAY

Ten rows of dots indicate each level of a workout in manual mode. Displays messages that help guide you through the programming process. During a program, the message window displays your workout data. The dots are only to show an approximate level (speed/incline) of effort. They do not necessarily indicate a specific value - only an approximate percent to compare levels of intensity. In Manual Operation, the Speed / Incline Dot Matrix Message Center will build a profile "picture" as values are changed during a workout. There are twenty-four columns indicating time. The 24 columns are divided into 1/24th of the total time of the program. When the time is counting up from zero (as in quick start), each column represents 1 minute.

Next to the Dot Matrix Message Center are three LED lights labelled: Track, Speed and Incline, along with an Up/Down Scan button. When the Track LED is lit, the Dot Matrix Message Center displays the Track profile; when the Speed LED is lit, the Dot Matrix Message Center displays the Speed profile, and when the Incline LED is lit, it displays the Incline profile. You may change the profile view by pressing the Up/Down Scan button. After scrolling through the three profiles, the Dot Matrix Message Center will automatically scroll through the three displays showing each one for four seconds. The LED associated with each profile will blink while that view is displayed. One more press of the Up/Down Scan button will return you to the Track profile.

0.4 KM (1/4 MILE) TRACK

The 1/4-mile track (0.4 km) and lap counter are located to the left of the dot matrix window. The flashing dot indicates your progress. In the center of the track, there is a lap counter for reference.

HEART RATE FEATURE

The Pulse (Heart Rate) window will display your current heart rate in beats per minute during the workout. You must use both left and right stainless steel sensors to pick up your pulse. Pulse values are displayed anytime the computer is receiving a Grip Pulse signal. You may use the Grip Pulse feature while in Heart Rate Control. The CT850 will also pick up wireless heart rate transmitters that are Polar compatible, including coded transmissions.

PROGRAMMABLE FEATURES TO SELECT AND START A PRESET PROGRAM

The Spirit Fitness CT850 offers twelve preset programs, Hill, Fat Burn, Cardio, Interval, HIIT (High-Intensity Interval Training), 5k Run, 10k Run, a Custom User-defined program, two heart rate control programs, a Fitness Test (Gerkin, Army, Navy, Airforce, Marine Corps, Coast Guard, PEB), and one Manual program.

1. Press the Program button to select a program, then press the Enter button to begin customizing the program with your personal data, or just press the Start button to begin the program with the default settings.
2. After selecting a program and pressing Enter to set your personal data, the Time window will blink with the default value of 20 minutes. You may use any of the Up/Down buttons to adjust the time. After adjusting the time, press Enter. (Note: You may press Start at any time during the programming, to begin with, only settings you have modified at that point).
3. The Incline window will now be blinking a value indicating your Age. Use the Up/Down buttons to adjust, and then press enter.

4. The Distance window will now be blinking a value indicating your body weight. Entering your correct body weight affects the Kcal readout accuracy. Use the Up/Down buttons to adjust, and then press Enter.
5. The Speed window will now be blinking, showing the preset top speed of the selected program. Use the Up/Down buttons to adjust, and then press Enter. Each program has various speed changes throughout; this allows you to limit the highest speed the program will attain during your workout.
6. Now press the Start button to begin your workout or the Stop button to return to the previous screen.
7. There will be a 3-minute warm-up to begin. You can press the Start button to bypass this and go straight to the workout. During the warm-up, the clock will count down from 3 minutes. (5k Run, 10k Run, HR 1 & 2, Custom, and Manual do not have warm-up)

PRESET PROGRAMS SPEED/INCLINE SETTINGS

The preset program Speed and Incline levels are shown in the chart below. The Speed numbers shown in the chart indicate a percentage of the top speed of the program. For instance, the first Speed setting for P1 (Program 1, HILL) shows the number 20. This means that this segment of the program will have a speed that is 20% of the top speed for the program (The user sets the top speed in the procedure above). If the user sets the top speed to 10 mph / 16 kph, then the first segment will be 2 mph / 3.2 kph. You will notice that segment 12 shows 100 which means, the speed will be set to 100% of 10 mph / 16 kph or simply 10 mph/ 16 kph.

P1= HILL; P2= FAT BURN; P3= CARDIO; P4= INTERVAL

Prog	SEG	Warm up	1	2	3	4	5	6	7	8	9	10	11	12	13	14	15	16	17	18	19	20	21	22	23	24	Cool down				
P1	Speed	20	30	40	50	60	60	70	70	70	80	80	80	100	100	70	80	80	70	70	80	80	70	60	60	50	40	30	20		
	Incline	0	0	0	0	1	2	3	3	4	3	3	4	4	5	3	3	4	3	3	4	4	5	4	3	1	1	0	0	0	0
P2	Speed	20	30	40	50	60	60	70	80	100	100	100	100	100	100	100	100	100	100	100	100	100	100	80	70	60	50	40	30	20	
	Incline	0	0	0	0	1	2	3	3	3	4	5	3	3	4	4	3	3	2	2	3	4	5	6	4	2	1	0	0	0	0
P3	Speed	20	30	40	50	60	60	70	70	70	80	70	70	80	80	60	70	80	80	70	70	100	70	80	60	60	50	40	30	20	
	Incline	0	0	0	0	1	1	1	2	2	3	2	2	3	3	1	2	3	3	2	2	4	4	2	3	1	1	0	0	0	0
P4	Speed	20	30	40	50	60	60	70	80	100	60	60	70	80	100	60	70	100	60	70	100	60	70	80	70	60	60	50	40	30	20
	Incline	0	0	0	0	1	2	3	5	6	2	3	5	6	7	2	3	7	2	3	8	2	3	5	4	3	1	0	0	0	0

HILL

This program follows a triangle or pyramid type of gradual progression from approximately 10% of maximum effort (the level that you chose before starting this program) up to a maximum effort that lasts for 10% of the total workout time, then a gradual regression of resistance back to approximately 10% of maximum effort.

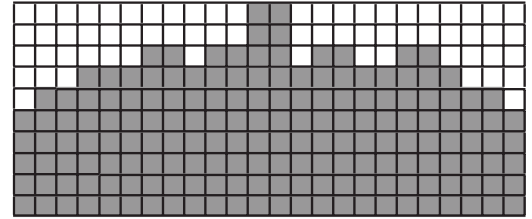

FATBURN

This program follows a quick progression up to the maximum resistance level (default or user input level) that is sustained for 2/3 of the workout. This program will challenge your ability to sustain your energy output for an extended period of time.

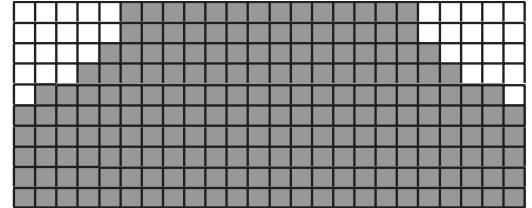

Cardio

This program presents a quick progression up to near maximum resistance level (default or user input level). It has slight fluctuations up and down to allow your heart rate to elevate and then recover repeatedly before beginning a quick cool down. This will build up your heart muscle and increase blood flow and lung capacity.

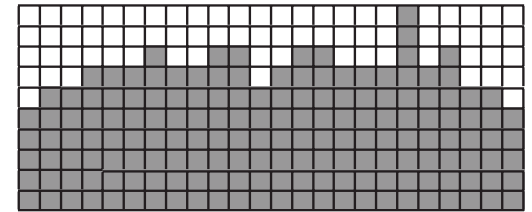

Interval

This program takes you through high levels of intensity, followed by recovery periods of low intensity. This program utilizes and develops your "Fast Twitch" muscle fibres which are used when performing tasks that are intense and short in duration. These deplete your oxygen level and spike your heart rate, followed by periods of recovery and heart rate drop to replenish oxygen. Your cardiovascular system gets programmed to use oxygen more efficiently.

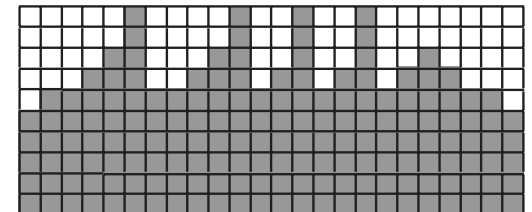

HIIT

The HIIT, or High-Intensity Interval Training, program takes advantage of the latest trend in fitness. During the program, you will perform short bursts of high-intensity sprinting followed by short rest periods. HIIT is a fully customizable interval training program. You can enter the number of intervals, time of each interval Sprint and Rest periods and the work intensity of the levels.

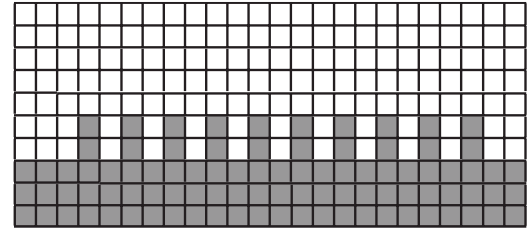

1. Using the Program button select the HIIT program, then press Enter. The Dot Matrix Message Center will ask you to enter your Age. You may enter your Age, using the Up and Down keys, then press the Enter key to accept the new number and proceed on to the next screen.
2. You are now asked to enter your Weight. You may adjust the Weight number using the Up and Down keys; then press Enter to continue.
3. Next, you are asked for the number of intervals you want to do. The default is 10, and the range available is 3 to 15. One interval equals 1 Sprint and 1 Rest segment.
4. Next, you will enter the Interval time. The Dot Matrix Message Center shows Sprint Time: 30 and Rest Time: 30. The Sprint time will be blinking. You may use the Up/ Down keys to adjust the Sprint time from 30 to 60 seconds, then press Enter. The time for the Rest period will blink, and you can adjust the time using the Up/Down keys and press Enter.
5. The Dot Matrix Message Center now displays SPRINT SPD 6.0 MPH. Use the Up/Down buttons to adjust the sprint speed you desire and press Enter.
6. The Dot Matrix Message Center now displays REST SPEED 3.0 MPH. Use the Up/Down buttons to adjust the res speed you desire and press Enter.
7. You may now press Start to begin the HIIT program. The program starts with a 3-minute warm-up period with the speed set to 50% of the sprint speed selected previously. You can manually adjust the speed during warm-up if you

CUSTOM PROGRAM

1. Select the Custom program using the Program button, then press Enter. Note that the Dot Matrix Message Center will light a single row of dots at the bottom (Unless there is a previously saved program).
2. The clock (Time) window will be flashing. Use the Up/Down buttons to set the program for the desired time. Press the Enter button. This is a must to continue even if the time is not adjusted.
3. The Incline window will now be blinking a value indicating your Age. Use the Up/Down buttons to adjust and then press Enter.
4. The Distance window will now be blinking a value indicating your Bodyweight. Entering your correct bodyweight affects the Calorie readout accuracy. Use the Up/Down buttons to adjust, and then press Enter.
5. The first-speed setting column (segment) will now be blinking. Using the Up/Down buttons, adjust the speed to your desired effort level for the first segment, then press Enter. The second column will now be blinking. Note that the previous segment value has been carried over to the new segment. Repeat the above process until all segments have been programmed.
6. The first column will be blinking again. The console is now ready for the incline settings. Repeat the same process used to set the speed values for programming the segments for incline.
7. Press the Start button to begin the workout and also save the program to memory.

5K RUN

This program automatically sets a 5k or 10k (5 or 10 kilometres) distance as your goal. The track display will show one loop that is the equivalent of 5 or 10 kilometres, and the Distance window will also show 5k or 10k to start. When the program begins, the Distance will count down; once it reaches zero, the program ends.

**Please note that the Speed readout is in MPH if the console is not set to Metric.*

FITNESS TEST

When the Fit-Test button is pressed, the dot matrix displays the 7 different tests available: Gerkin, Army, Navy, Air Force, Marines, PEB, Coast Guard. To select your desired fitness test, use the arrow button and press enter.

FITNESS TEST OPERATION

1. The Dot Matrix Message Window will ask you to enter your Weight. You may adjust the weight setting, shown in the Distance window, using the Up and Down buttons, then press the Enter button to accept the new number and proceed on to the next screen.
2. You are now asked to enter your Age. You may adjust the age setting, shown in the Incline window, using the Up and Down buttons, then press Enter to continue.
3. You are now asked to enter your Gender. You may adjust the gender setting, shown in the Incline window, using the Up and Down buttons, then press Enter to continue.
4. Now press Start to begin the test.

GERKIN TEST

The Gerkin protocol, also known as the fireman's protocol, is a sub-max Vo2 (volume of oxygen) test.

The test will increase speed and elevation alternately until you reach 85% of your Max heart rate. The time it takes for you to reach 85% determines the test score (VO2max), as shown in the chart below.

Stage	Time	Speed	Grade	VO2 Max
1	0 to 1:00	7.2KPH	0%	31.15
2.1	1:00	7.2KPH	2%	32.55
2.2	1:30	7.2KPH	2%	33.6
2.3	1:45	7.2KPH	2%	34.65
2.4	2:00	8.0KPH	2%	35.35
3.1	2:15	8.0KPH	2%	37.45
3.2	2:30	8.0KPH	2%	39.55
3.3	2:45	8.0KPH	2%	41.3
3.4	3:00	8.0KPH	4%	43.4
4.1	3:15	8.0KPH	4%	44.1
4.2	3:30	8.0KPH	4%	45.15
4.3	3:45	8.0KPH	4%	46.2
4.4	4:00	8.8KPH	4%	46.5
5.1	4:15	8.8KPH	4%	48.6
5.2	4:30	8.8KPH	4%	50
5.3	4:45	8.8KPH	4%	51.4
5.4	5:00	8.8KPH	6%	52.8
6.1	5:15	8.8KPH	6%	53.9
6.2	5:30	8.8KPH	6%	54.9
6.3	5:45	8.8KPH	6%	56
6.4	6:00	9.6KPH	6%	57
7.1	6:15	9.6KPH	6%	57.7
7.2	6:30	9.6KPH	6%	58.8
7.3	6:45	9.6KPH	6%	60.2
7.4	7:00	9.6KPH	8%	61.2
8.1	7:15	9.6KPH	8%	62.3
8.2	7:30	9.6KPH	8%	63.3
8.3	7:45	9.6KPH	8%	64
8.4	8:00	10.4KPH	8%	65
9.1	8:15	10.4KPH	8%	66.5
9.2	8:30	10.4KPH	8%	68.2
9.3	8:45	10.4KPH	8%	69
9.4	9:00	10.4KPH	10%	70.7
10.1	9:15	10.4KPH	10%	72.1
10.2	9:30	10.4KPH	10%	73.1
10.3	9:45	10.4KPH	10%	73.8
10.4	10:00	11.2KPH	10%	74.9
11.1	10:15	11.2KPH	10%	76.3
11.2	10:30	11.2KPH	10%	77.7
11.3	10:45	11.2KPH	10%	79.1
11.4	11:00	11.2KPH	10%	80

Stage	Time	Speed	Grade	VO2 Max
1	0 to 1:00	4.5MPH	0%	31.15
2.1	1:00	4.5MPH	2%	32.55
2.2	1:30	4.5MPH	2%	33.6
2.3	1:45	4.5MPH	2%	34.65
2.4	2:00	5.0MPH	2%	35.35
3.1	2:15	5.0MPH	2%	37.45
3.2	2:30	5.0MPH	2%	39.55
3.3	2:45	5.0MPH	2%	41.3
3.4	3:00	5.0MPH	4%	43.4
4.1	3:15	5.0MPH	4%	44.1
4.2	3:30	5.0MPH	4%	45.15
4.3	3:45	5.0MPH	4%	46.2
4.4	4:00	5.5MPH	4%	46.5
5.1	4:15	5.5MPH	4%	48.6
5.2	4:30	5.5MPH	4%	50
5.3	4:45	5.5MPH	4%	51.4
5.4	5:00	5.5MPH	6%	52.8
6.1	5:15	5.5MPH	6%	53.9
6.2	5:30	5.5MPH	6%	54.9
6.3	5:45	5.5MPH	6%	56
6.4	6:00	6.0MPH	6%	57
7.1	6:15	6.0MPH	6%	57.7
7.2	6:30	6.0MPH	6%	58.8
7.3	6:45	6.0MPH	6%	60.2
7.4	7:00	6.0MPH	8%	61.2
8.1	7:15	6.0MPH	8%	62.3
8.2	7:30	6.0MPH	8%	63.3
8.3	7:45	6.0MPH	8%	64
8.4	8:00	6.5MPH	8%	65
9.1	8:15	6.5MPH	8%	66.5
9.2	8:30	6.5MPH	8%	68.2
9.3	8:45	6.5MPH	8%	69
9.4	9:00	6.5MPH	10%	70.7
10.1	9:15	6.5MPH	10%	72.1
10.2	9:30	6.5MPH	10%	73.1
10.3	9:45	6.5MPH	10%	73.8
10.4	10:00	7.0MPH	10%	74.9
11.1	10:15	7.0MPH	10%	76.3
11.2	10:30	7.0MPH	10%	77.7
11.3	10:45	7.0MPH	10%	79.1
11.4	11:00	7.0MPH	10%	80

WHAT YOUR SCORE MEANS

VO2max Chart for males and very fit females

	18-25 years old	26-35 years old	36-45 years old	46-55 years old	56-65 years old	65+ years old
excellent	>60	>56	>51	>45	>41	>37
good	52-60	49-56	43-51	39-45	36-41	33-37
above average	47-51	43-48	39-42	35-38	32-35	29-32
average	42-46	40-42	35-38	32-35	30-31	26-28
below average	37-41	35-39	31-34	29-31	26-29	22-25
poor	30-36	30-34	26-30	25-28	22-25	20-21
very poor	<30	<30	<26	<25	<22	<20

VO2max Chart for females and de-conditioned males

	18-25 years old	26-35 years old	36-45 years old	46-55 years old	56-65 years old	65+ years old
excellent	56	52	45	40	37	32
good	47-56	45-52	38-45	34-40	32-37	28-32
above average	42-46	39-44	34-37	31-33	28-31	25-27
average	38-41	35-38	31-33	28-30	25-27	22-24
below average	33-37	31-34	27-30	25-27	22-24	19-22
poor	28-32	26-30	22-26	20-24	18-21	17-18
very poor	<28	<26	<22	<20	<18	<17

ARMY

A timed 2 mile / 3.2 kph run. You control the speed manually.
Maximum time allowed to pass the test:

Age	Male	Female
17-21	16:36	19:42
22-26	17:30	20:36
27-31	17:54	21:42
32-36	18:48	23:06
37-41	19:30	24:06

For more detailed information, visit: <http://bit.ly/SF-Army>

AIR FORCE

A timed 1.5 mile / 2.4kph run. You control the speed manually.
Maximum time allowed to pass the test:

Age	Male	Female
<30	13:36	16:22
30-39	14:00	16:57
40-49	14:52	18:14
50-59	16:22	19:43
60+	18:14	22:28

For more detailed information, visit: <http://bit.ly/SF-AirForce>

NAVY

A timed 1.5 mile/ 2.4 kph run. You control the speed manually.
Maximum time allowed to pass the test:

Age	Male	Female
17-21	16:36	19:42
22-26	17:30	20:36
27-31	17:54	21:42
32-36	18:48	23:06
37-41	19:30	24:06

Age	Male	Female
45-49	16:09	17:02
50-54	16:46	17:27
55-59	17:10	18:35
60-64	18:53	19:44
65+	20:36	20:53

For more detailed information, visit: <http://bit.ly/SF-Navy>

MARINES

A timed 3 miles/ 4.8 kph run. You control the speed manually.

Maximum time allowed to pass the test:

Age	Male	Female
17-26	28:00	31:00
27-39	29:00	32:00
40-45	30:00	33:00
46+	33:00	36:00

For more detailed information, visit: <http://bit.ly/SF-Marines>

PEB

A timed 1.5 mile/ 2.4kph run. You control the speed manually.

Maximum time allowed to pass the test:

Age	Male	Female
20-24	10:43	13:36
25-29	11:05	13:43
30-34	11:26	13:43
35-39	11:47	14:37
40-44	12:28	15:12

Age	Male	Female
45-49	13:07	16:02
50-54	13:49	17:02
55-59	14:48	17:37
60+	15:07	17:37

For more information, visit: <http://bit.ly/SF-Peb>

COAST GUARD

A timed 1.5 mile/ 2.4kph run. You control the speed manually.

Maximum time allowed to pass the test:

Age	Male	Female
<30	12:52	15:27
30-39	13:37	15:58
40-49	14:30	16:59
50-59	15:27	17:56
60+	16:41	18:46

For more information, visit: <http://bit.ly/SF-CoastGuard>

Before The Test:

- Make sure you are in good health; check with your physician before performing any exercise if you are over the age of 35 or persons with pre-existing health conditions.
- Make sure you have warmed up and stretched before taking the test.
- Do not take in caffeine before the test.
- Hold the handgrips gently, do not tense up.

During the Test:

- The console must be receiving a steady heart rate for the test to begin. You may use the hand pulse sensors or wear a heart rate chest strap transmitter.
- The test will start with a 3 minute warm-up at 3 MPH before the actual test begins.
- The data shown during the test is:
 - a. Time indicates total elapsed time
 - b. Incline in percent grade
 - c. Distance in Miles or Kilometers depending on preset parameter.
 - d. Speed in MPH or KPH depending on preset parameter.
 - e. Target Heart Rate and Actual Heart Rate are shown in the Dot Matrix Message Center.

After the Test

- Cool down for about one to three minutes.
- Take note of your score because the console will automatically return to the start-up mode after a few minutes.

HEART RATE PROGRAMS

The old motto, "no pain, no gain," is a myth that has been overpowered by the benefits of exercising comfortably. A great deal of this success has been promoted by the use of heart rate monitors. With the proper use of a heart rate monitor, many people find that their choice of exercise intensity is either too high or too low, and exercise is much more enjoyable by maintaining their heart rate in the desired benefit range.

To determine the benefits range in which you wish to train, you must first determine your Maximum Heart Rate. This can be accomplished by using the following formula: 220 minus your age. This will give you the Maximum heart rate (MHR) for someone of your age. To determine the effective heart rate range for specific goals, you simply calculate a percentage your MHR. Your Heart rate training zone is 50% to 90% of your maximum heart rate.

65% of your MHR is the zone that burns fat, while 85% is for strengthening the cardiovascular system. This 65% to 85% is the zone to stay in for maximum benefit.

For someone who is 40 years old their target heart rate zone is calculated:

$$220 - 40 = 180 \text{ (maximum heart rate)}$$
$$180 \times .65 = 117 \text{ beats per minute (65\% of maximum)}$$
$$180 \times .85 = 153 \text{ beats per minute (85\% of maximum)}$$

So for a 40-year-old, the training zone would be 117 to 153 beats per minute.

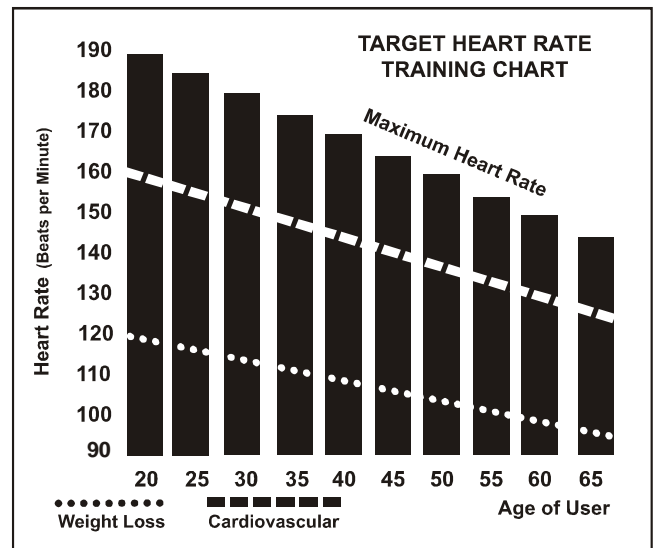

If you enter your age during programming, the console will perform this calculation automatically. Entering your age is used for the Heart Rate control programs. After calculating your Maximum Heart Rate, you can decide upon which goal you would like to pursue.

The two most popular reasons for, or goals, of exercise, are cardiovascular fitness (training for the heart and lungs) and weight control. The black columns on the chart above represent the Maximum Heart Rate for a person whose age is listed at the bottom of each column. The training heart rate, for either cardiovascular fitness or weight loss, is represented by two different lines that cut diagonally through the chart. A definition of the lines' goal is in the bottom left-hand corner of the chart. If your goal is cardiovascular fitness or if it is weight loss, it can be achieved by training at 85% or 65%, respectively, of your Maximum Heart Rate on a schedule approved by your physician. Consult your physician before participating in any exercise program.

CAUTION!

The target value used in HR programs is a suggestion only for normal, healthy individuals. Do not exceed your limits! You may not be able to obtain your chosen target. If in question, enter a higher age value that will set a lower target goal.

HEART RATE CONTROL

Heart Rate Control (HRC) uses your treadmill's incline system to control your heart rate. Increases and decreases in elevation affect heart rate much more efficiently than changes in speed alone. The HRC program automatically changes elevation gradually to achieve the programmed target heart rate.

Selecting a Heart Rate Control Program:

You have the option, during the setup mode, to choose either the Weight Control (HR-1) program or the Cardiovascular (HR-2) program. The Weight Control program will attempt to maintain your heart rate at 65% of your Maximum Heart Rate. The Cardiovascular program will attempt to maintain your heart rate at 80% of your Maximum Heart Rate. Your Maximum Heart Rate is based upon a formula that subtracts your age from a constant of 220. Your HR setting is automatically calculated during the setup mode when you enter your age.

HEART RATE CONTROL PROGRAMMING

1. You must receive a strong/steady value in heart rate window, or the program will not start. Dot Matrix Message Center will show "Check Pulse" if there is no pulse signal.
2. Use the Program button to select the HR program to begin.
3. The Dot Matrix Message Center will show "Press Enter to modify or Start to begin workout." You can either press the Enter button for settings or press the Start button to execute the default program.
4. When Enter is pressed, the Dot Matrix Message Center will read, "Press 1 or 2 to select then press Enter". At the same time, the Dot Matrix Message Center will show "1".
5. The Dot Matrix Message Center will show "Adjust Time then press Enter" with the Time window blinking. Use the Up/Down & Fast/Slow buttons to adjust. After setting a time, press Enter.
6. The Dot Matrix Message Center will prompt you to enter Age. Press Enter once adjusted.
7. The Dot Matrix Message Center will prompt you to enter Body Weight. Press Enter once adjusted.
8. The Dot Matrix Message Center will prompt you to enter Heart Rate. Press Enter once adjusted.
9. Press Start to begin your workout or Enter to modify. Press Stop to return to the previous screen.

BLUETOOTH

Connect your device via Bluetooth FTMS (connects to fitness apps).

How to connect chest strap via Bluetooth:

1. The default setting is for the Bluetooth App connection. If the user wants to change the setting for pairing with a Bluetooth chest strap, please follow the below instructions:
 - A. While the treadmill is in idle mode, press the “Scan”  button into pairing mode.
 - B. When the message window shows “APP, press either Incline▲/▼, Speed▲/▼ or Enter ▲/▼ to cycle through to BLECHESTSTRAP function, then press Enter to return to idle mode.
 - C. Bluetooth chest strap can be paired to the machine.

RATE OF PERCEIVED EXERTION

Heart rate is important but listening to your body also has a lot of advantages. There are more variables involved in how hard you should work out than just heart rate. Your stress level, physical health, emotional health, temperature, humidity, the time of day, the last time you ate and what you ate all contribute to the intensity at which you should workout. If you listen to your body, it will tell you all of these things.

The rate of perceived exertion (RPE), also known as the Borg scale, was developed by Swedish physiologist G.A.V. Borg. This scale rates exercise intensity from 6 to 20 depending upon how you feel or the perception of your effort.

The Borg scale is as follows:

Rating Perception of Effort

- 6** Minimal
- 7** Very, very light
- 8** Very, very light +
- 9** Very light
- 10** Very light +
- 11** Fairly light
- 12** Comfortable
- 13** Somewhat hard
- 14** Somewhat hard +
- 15** Hard
- 16** Hard +
- 17** Very hard
- 18** Very hard +
- 19** Very, very hard
- 20** Maximal

You can get an approximate heart rate level for each rating by simply adding a zero to each rating. For example, a rating of 12 will result in an approximate heart rate of 120 beats per minute. Your RPE will vary depending on the factors discussed earlier. That is the major benefit of this type of training. If your body is strong and rested, you will feel strong, and your pace will feel easier. When your body is in this condition, you are able to train harder, and the RPE will support this. If you are feeling tired and sluggish, it is because your body needs a break. In this condition, your pace will feel harder. Again, this will show up in your RPE, and you will train at the proper level for that day.

USING A HEART RATE TRANSMITTER

(OPTIONAL)

How to wear your wireless chest strap transmitter:

1. Attach the transmitter to the elastic strap using the locking parts.
2. Adjust the strap as tightly as possible as long as the strap is not too tight to remain comfortable.
3. Position the transmitter with the logo centred in the middle of your body facing away from your chest (some people must position the transmitter slightly left of center). Attach the final end of the elastic strap by inserting the round end and, using the locking parts, secure the transmitter and strap around your chest.
4. Position the transmitter
5. immediately below the pectoral muscles.
6. Sweat is the best conductor to measure very minute heartbeat electrical signals. However, plain water can also be used to pre-wet the electrodes (2 ribbed oval areas on the reverse side of the belt and both sides of the transmitter). It's also recommended that you wear the transmitter strap a few minutes before your workout. Some users, because of body chemistry, have a more difficult time in achieving a strong, steady signal at the beginning. After "warming up," this problem lessens. As noted, wearing clothing over the transmitter/strap doesn't affect performance.
7. Your workout must be within range - distance between transmitter/receiver – to achieve a strong, steady signal. The length of range may vary somewhat but generally stay close enough to the console to maintain good, strong, reliable readings. Wearing the transmitter immediately against bare skin assures you of proper operation. If you wish, you may wear the transmitter over a shirt. To do so, moisten the areas of the shirt that the electrodes will rest upon.



Note: The transmitter is automatically activated when it detects activity from the user's heart. Additionally, it automatically deactivates when it does not receive any activity. Although the transmitter is water-resistant, moisture can have the effect of creating false signals, so you should take precautions to completely dry the transmitter after use to prolong battery life (estimated transmitter battery life is 2500 hours). The replacement battery is Panasonic CR2032.

ERRATIC OPERATION

Caution! Do not use this treadmill for Heart Rate programs unless a steady, solid Actual Heart Rate value is being displayed. High, wild, random numbers being displayed indicate a problem.

Areas to look for interference that may cause erratic heart rate:

1. Microwave ovens, TVs, small appliances, etc.
2. Fluorescent lights.
3. Some household security systems.
4. Electric fence for a pet.
5. Some people have problems with the transmitter picking up a signal from their skin. If you have problems, try wearing the transmitter upside down.
6. The antenna that picks up your heart rate is very sensitive. If there is an outside noise source, turning the whole machine 90 degrees may de-tune the interference.
7. Another Individual wearing a transmitter within 3' of your machine's console.

If you continue to experience problems, contact your dealer.

EXPLODED VIEW DIAGRAM

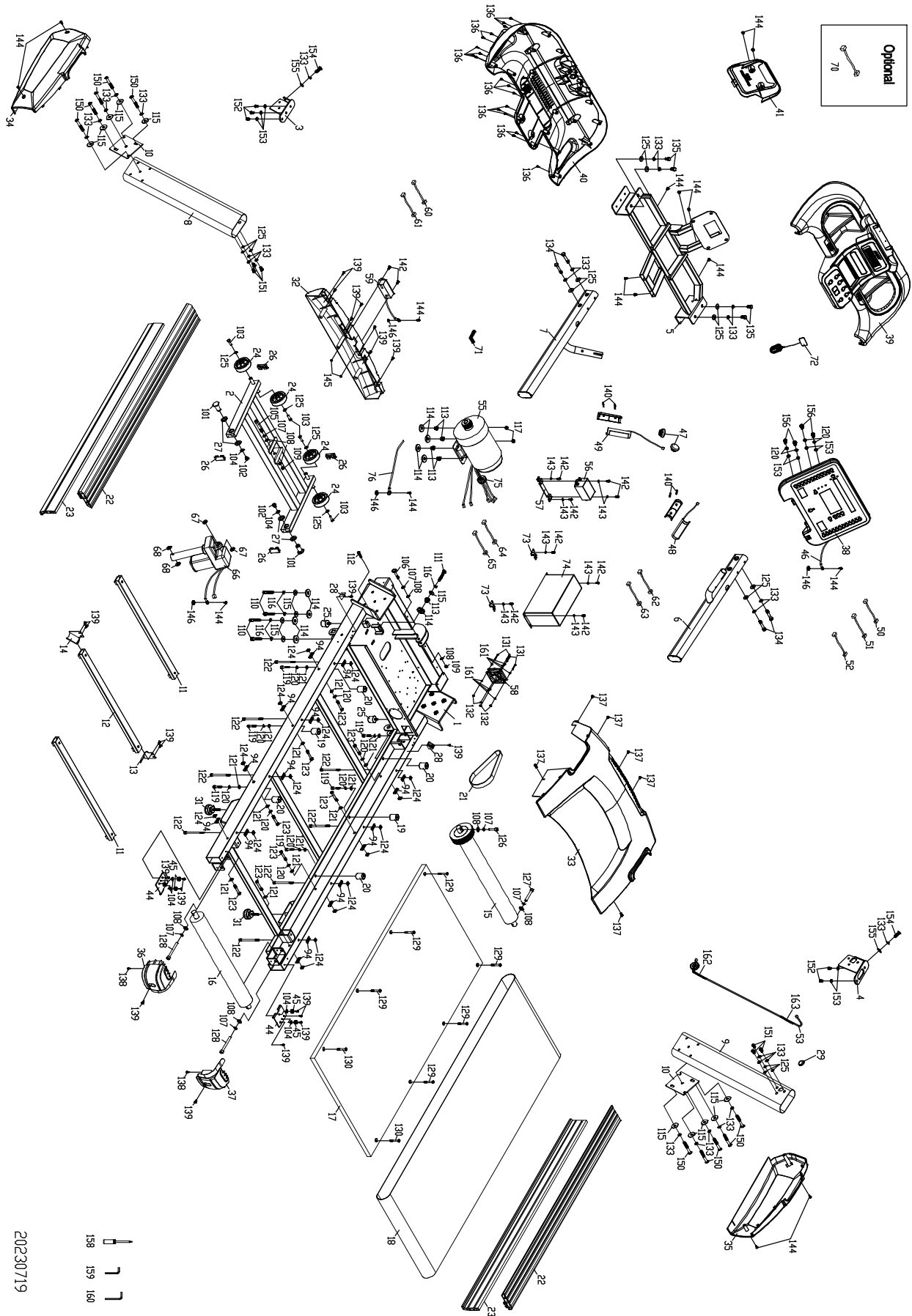

20230719

PARTS LIST

KEY NO.	DESCRIPTION	Q'TY
1	Main Frame	1
2	Incline Bracket	1
3	Locking Plate Assembly (L)	1
4	Locking Plate Assembly (R)	1
5	Console Support	1
6	Handlebar (R)	1
7	Handlebar (L)	1
8	Left Upright	1
9	Right Upright	1
10	Upright Fixing Plate	2
11	Running Deck Stabilizer Assembly(A)	2
12	Running Deck Stabilizer Assembly(B)	1
13	Belt Guide(R)	1
14	Belt Guide(L)	1
15	Front Roller W/Pulley	1
16	Rear Roller	1
17	Running Deck	1
18	Running Belt	1
19	Cushion A	2
20	Cushion B	4
21	Drive Belt	1
22	Foot Rail(Upper)	2
23L	Foot Rail (L)	1
23R	Foot Rail (R)	1
24	Transportation Wheel	4
25	Incline Rubber Foot	2
26	Square End Cap	4
27	Stable Wheel Spacer	4
28	Motor Cover Anchor(D)	2
29	Round Cap	1
31	Foot Pad	2
32	Front Motor Cover	1
33	Motor Top Cover	1
34	Motor Base Cap (L)	1
35	Motor Base Cap (R)	1
36	Rear Adjustment Base (L)	1
37	Rear Adjustment Base (R)	1
38	Console Assembly	1
39	Rack Top Cover	1
40	Rack Bottom Cover	1
41	Console Cover	1
44	Adjustment Rail Pad	2
45	Rubber Foot Pad	4
46	300m/m_Ground Wire	1
47	Handpulse End Cap	2

KEY NO.	DESCRIPTION	Q'TY
48	900m/m_Handpulse W/Cable Assembly(SMP-03)	1
49	900m/m_Handpulse W/Cable Assembly(SMR-03)	1
50	400m/m_Handpulse Wire (Upper)	1
51	400m/m_Handpulse Wire (Upper)	1
52	1100m/m_Computer Cable(Upper)	1
53	2000m/m_Computer Cable	1
55	AC Drive Motor	1
56	Filter	1
57	Filter Plate	1
58	Fan	1
59	AC Electronic Module	1
60	450m/m_Connecting Wire (White)	1
61	450m/m_Connecting Wire (Black)	1
62	350m/m_Connecting Wire(White)	1
63	350m/m_Connecting Wire (Black)	1
64	400m/m_Motor Fan Connecting Cable(Black)	1
65	400m/m_Motor Fan Connecting Cable(White)	1
66	Incline Motor	1
67	Ø10 x Ø25 x 0.8T_Nylon Washer	2
68	Ø10 x Ø25 x 2.5T_Nylon Washer	2
70	Power Cord	1
71	TV Adapter (5C2V)	1
72	Square Safety Key	1
73	Inverter Plate	2
74	Inverter	1
75	Ø35x21x13L_Ferrite Core	1
76	300m/m_Ground Wire	1
94	Ø30 x 14 x 1.5T x 3.5H_Concave Washer	16
101	Ø18 x Ø19 x 41L_Carriage Bolt	2
102	M8 x 12m/m_Hex Head Bolt	2
103	3/8" x 25m/m_Hex Head Bolt	4
104	Ø8.5 x Ø26 x 2.0T_Flat Washer	6
105	M10 x P1.5 x 65m/m_Hex Head Bolt	1
106	M10 x P1.5 x 50m/m_Hex Head Bolt	1
107	Ø10 x 1.5T_Split Washer	6
108	Ø3/8" x Ø19 x 1.5T_Flat Washer	8
109	M10 x P1.5 x 8T_Nylon Nut	2
110	3/8" x UNC16 x 2" _Socket Head Cap Bolt	4
111	3/8" x 2-1/2" _Hex Head Bolt	1
112	3/8" x UCN16 x 2" _Socket Head Cap Bolt	1
113	Ø10 x Ø14 x 14L_Bushing	5
114	Ø13 x Ø35 x 5T_Nylon Washer	9
115	Ø3/8" x 35 x 2.0T_Flat Washer	15
116	Ø10 x 2.0T_Split Washer	5
117	3/8" x 7T_Nylon Nut	2

KEY NO.	DESCRIPTION	Q'TY
119	M8 x 1.25 x 40m/m_Socket Head Cap Bolt	6
120	Ø8 x 1.5T_Split Washer	14
121	Ø5/16" x 16 x 1.0T_Flat Washer	14
122	M8 x 1.25 x 95m/m_Button Head Socket Bolt	8
123	M8 x 55m/m_Hex Head Bolt	8
124	M8 x 1.25 x 6.5T_Square Nut	16
125	Ø3/8" x Ø25 x 2.0T_Flat Washer	18
126	M10 x 40m/m_Socket Head Cap Bolt	1
127	M10 x 80m/m_Socket Head Cap Bolt	1
128	M10 x 100m/m_Socket Head Cap Bolt	2
129	M8 x P1.25 x 55L_Flat Head Countersink Bolt	6
130	M8 x 35m/m_Flat Head Countersink Bolt	2
131	M3 x 40m/m_Phillips Head Screw	4
132	M3 x 5T_Nylon Nut	4
133	Ø10 x 2T_Split Washer	26
134	3/8" x 2-1/4" _Hex Head Bolt	4
135	3/8" x 3/4" _Hex Head Bolt	4
136	3.5 x 12m/m_Sheet Metal Screw	18
137	5 x 12m/m_Sheet Metal Screw	6
138	5 x 25m/m_Tapping Screw	2
139	5 x 19m/m_Tapping Screw	23
140	3 x 25m/m_Tapping Screw	4
142	M5 x 12m/m_Phillips Head Screw	10
143	Ø5 x 1.5T_Split Washer	8
144	M5 x 12m/m_Phillips Head Screw	16
145	M5 x 5T_Nylon Nut	2
146	M5_Star Washer	4
150	3/8" x 3" _Button Head Socket Bolt	10
151	3/8" x 3/4" _Button Head Socket Bolt	6
152	M8 x 12m/m_Socket Head Cap Bolt	5
153	Ø8 x Ø16 x 2T_Flat Washer	9
154	3/8" x UNC16 x 1-1/4" _Button Head Socket Bolt	2
155	Ø10 x Ø23 x 1.5T_Curved Washer	2
156	M8 x P1.25 x 20L_Socket Head Cap Bolt	4
158	Phillips Head Screwdriver	1
159	L Allen Wrench	1
160	Allen Wrench	1
161	Isolation Pad	8
162	Ending Tape(400m/m)	1
163	Ending Tape(200m/m)	1

GENERAL MAINTENANCE

MAINTENANCE OF RUNNING BELT/DECK:

Your treadmill uses a very high-efficient and proprietary belt/deck combination. Performance is maximized when the deck is kept as clean as possible. Use a soft, damp cloth, or paper towel, wipe the edge of the belt and the area between the belt edge and the frame. Also reach as far as practical directly under the belt edge. This should be done once a month to extend belt and deck life. A mild soap and water solution along with a nylon scrub brush will clean the top of the textured belt. Allow to dry before using. The low maintenance (routine monthly cleaning), dual sided deck is designed to withstand up to 4,000 hrs on each side. If the original side of the deck use is over 4000 hrs, then it needs to be flipped. Contact your service technician for assistance. Do not apply any type of lubricant or wax to the surface.

Belt Dust - This occurs during normal break-in or until the belt stabilizes. Wiping excess off with a damp cloth will minimize buildup.

General Cleaning - Dirt, dust, and pet hair can block air inlets and accumulate on the running belt. On a monthly basis: vacuum underneath your treadmill to prevent buildup. Once a year, you should remove the black motor hood and vacuum out dirt that may accumulate. **UNPLUG POWER CORD BEFORE THIS TASK.**

BELT ADJUSTMENTS:

Tread-belt Tension Adjustment - Adjustment must be made from the rear roller. The adjustment bolts are located at the end of the step rails in the end caps, as noted in the diagram below.

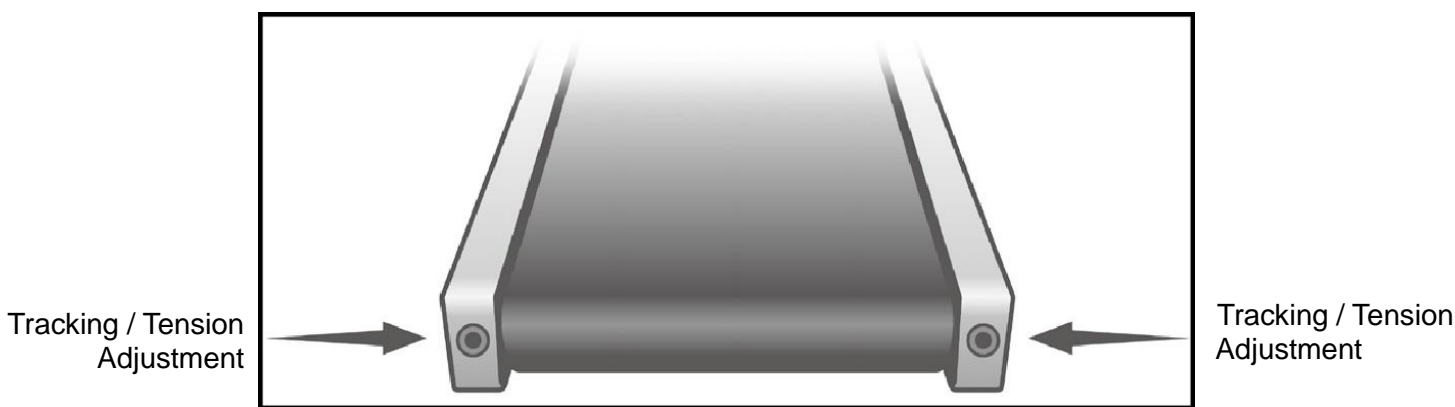

Note: Adjustment is through small hole in the end cap.

Tighten the rear roller bolts only enough to prevent slippage at the front roller. Turn both tread-belt tension adjustment bolts in increments of 1/4, turn each and inspect for proper tension by walking on the belt at a low speed, making sure the belt does not slip. When an adjustment is made to the belt tension, you must be sure to turn the bolts on both sides evenly, or the belt could start tracking to one side instead of running in the middle of the deck.

DO NOT OVERTIGHTEN – Over tightening will cause belt damage and premature bearing failure. If you feel the belt is tight enough, but it still slips, the problem may be a loose Motor drive belt under the front cover.

TREADBELT TRACKING ADJUSTMENT:

The performance of your treadmill is dependent on the frame running on a reasonably level surface. If the frame is not level, the front and back roller cannot run parallel, and constant belt adjustment may be necessary.

The treadmill is designed to keep the tread-belt reasonably centred while in use. It is normal for some belts to drift near one side while the belt is running with no one on it. After a few minutes of use, the tread-belt should have a tendency to center itself. If during use, the belt continues to move toward one side, adjustments are necessary.

TO SET TREAD BELT TRACKING:

An 8mm Allen wrench is provided for this adjustment. Make tracking adjustments on the left side bolt. Set the belt speed to 3 mph. Be aware that a small adjustment can make a dramatic difference that may not be apparent right away. If the belt is too close to the left side, then turn the bolt only a 1/4 turn to the right (clockwise) and wait a few minutes for the belt to adjust itself. Continue to make 1/4 turns until the belt stabilizes in the center of the running deck.

If the belt is too close to the right side, turn the bolt counter-clockwise. The belt may require periodic tracking adjustment depending on use and walking/running characteristics. Some users may affect tracking differently. Expect to make adjustments as required to center the tread belt. Adjustments will become less of a maintenance concern as the belt is used. Proper belt tracking is an owner responsibility common with all treadmills

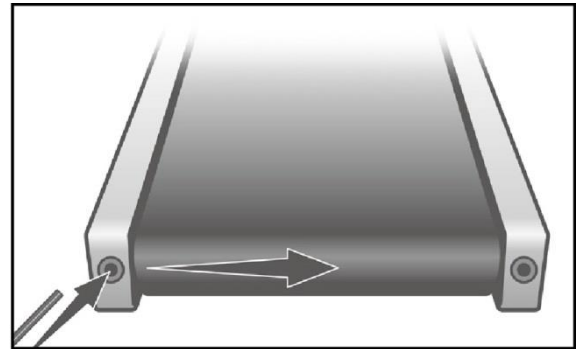

ATTENTION:

DAMAGE TO THE RUNNING BELT RESULTING FROM IMPROPER TRACKING / TENSION ADJUSTMENTS IS NOT COVERED UNDER THE SPIRIT WARRANTY.

CALIBRATION PROCEDURE

1. Remove the safety key.
2. Press and hold down the Start and Speed Up buttons and replace the safety button. Continue to hold the Start and Speed Up button until the window displays "Factory settings," then press the Enter button.
3. You will now be able to set the display to show Metric or Imperial settings (Meters vs. Miles). To do this, press the Up or Down button to show which you want, then press Enter.
4. Make sure the wheel size diameter is 2.98, then press Enter.
5. Adjust the minimum speed (if needed) to 0.5 and then press Enter.
6. Adjust the maximum speed (if needed) to 12.0 and then press Enter.
7. Adjust the maximum elevation (if needed) to 15 and then press Enter.
8. Press Start to begin calibration. The process is automatic; the speed will start up without warning, so do not stand on the belt.

ADJUSTING THE SPEED SENSOR

If the calibration does not pass, you may need to check the speed sensor alignment.

1. Remove the motor cover hood by loosening the 8 screws that hold it in place. Set it aside.
2. The speed sensor is located on the left side of the frame, right next to the front roller pulley (the pulley will have a belt around it that also goes to the motor). The speed sensor is a small rectangular shaped black box with a wire connected to it.
3. You will see a magnet on the outside edge of the pulley; make sure the speed sensor is aligned with the center of the magnet when it passes by. There are two screws that hold the sensor in place that need to be loosened to adjust the sensor. Re-tighten the screws when finished.



GENERAL MAINTENANCE

1. After each workout, wipe down all areas exposed to sweat with a damp cloth.
2. Ensure all bolts are properly tightened after assembly and before each use.
3. Ensure that the unit is properly levelled after assembly and before each use. Use levelling pads on the bottom of the feet to adjust height.

ENGINEERING MODE MENU

The console has built-in maintenance/diagnostic software. The software will allow you to change the console settings from English to Metric and turn off the beeping of the speaker when a button is pressed, for example. To enter the Engineering Mode Menu, press and hold down the Start, Stop and Enter buttons, then insert the safety button. Keep holding the buttons down for about 5 seconds until the Message Center displays Engineering Mode Menu. Press the Enter button to access the menu below:

1. Key Test (Will allow you to test all the buttons to make sure they are functioning).
2. Display Test (Tests all the display functions).
3. Security (Allows the keypad to be locked to prevent unauthorized use).
4. Functions (Press Enter to access settings and Up arrow to scroll).
 - a. Sleep Mode -Turn on to have the console power down automatically after 30 minutes of inactivity.
 - b. Pause Mode -Turn on, allow 5 minutes of pause, turn off to have the console pause indefinitely.
 - c. Maintenance - Reset maintenance reminder message and odometer readings.
 - d. Units -Sets the display to readout in Imperial (miles, pounds, feet, etc.) or Metric (kilometres, kilograms, meters, etc.) display measurements.
 - e. GS Mode - Returns the elevation to lowest setting when pause is pressed.
 - f. Beep Mode- Turns the speaker (beep sound) on or off.
5. Security - Sets the Child Lock function. This function locks out the keypad until a pre-determined key sequence is pressed. Key sequence = Incline UP held down together until unlocked.

SERVICE CHECKLIST - DIAGNOSIS GUIDE

Before contacting your dealer for aid, please review the following information. It may save you both time and expense. This list includes common problems that may not be covered under the treadmill's warranty.

PROBLEM	SOLUTION/CAUSE
Display does not light	<ol style="list-style-type: none"> 1) Tether cord not in position. 2) Circuit breaker on front grill tripped. Push circuit breaker in until it locks. 3) Plug is disconnected. Make sure plug is firmly pushed into 110-120 VAC wall outlet. 4) Breaker panel circuit breaker may be tripped. 5) Treadmill defect. Contact your dealer.
Tread-belt does not stay centered weight belt	<p>The user may be walking while favouring or putting more on either the left or right foot. If this walking pattern is natural, track the belt slightly off-center to the side opposite from the movement.</p> <p>See General Maintenance section on Tread-belt Tension. Adjust as necessary.</p>
Treadmill belt hesitates when walked/run on	<ol style="list-style-type: none"> 1) If the belt moves but stops after a short time and the display shows "LS," run calibration 2) If you press start and the belt never moves, then the display shows LS, contact service.
Motor is not responsive after pressing start	<p>This indicates motor should be receiving power to operate. Low AC voltage to treadmill. Do not use an extension cord. Low household voltage. Contact an electrician or your dealer. A minimum of 120 volt AC current is required.</p>
Treadmill will only achieve approximately 7 mph but shows higher speed on display	<p>High belt/deck friction. See General Maintenance. If cleaning doesn't prevent this from reoccurring, check the amp draw of the motor. If this is high and there are signs of significant wear of the deck, it may need to be flipped if it is on its original side.</p>
Treadmill trips on board 20 amp circuit	<p>Treadmill may not be grounded. Static electricity is "crashing." the computer. Refer to Grounding Instructions</p>
Computer shuts off when console is touched (on a cold day) while walking/running	<p>Check that the treadmill is the only object in the circuit. See "Important Electrical Information" in the front of this manual for more details.</p>
Circuit breaker trips, but not the treadmill circuit breaker.	<p>Tighten all bolts. Check that machine is levelled. Adjust levellers if needed using a wrench.</p>

TRAINING GUIDELINES

EXERCISE

Exercise is one of the most important factors in the overall health of an individual. Listed among its benefits are:

- Increased capacity for physical work (strength endurance)
- Increased cardiovascular (heart and arteries/veins) and respiratory efficiency
- Decreased risk of coronary heart disease
- Changes in body metabolism, e.g. losing weight
- Delaying the physiological effects of age
- Physiological effects, e.g. reduction in stress, increase in self-confidence, etc.

BASIC COMPONENTS OF PHYSICAL FITNESS

There are four all-encompassing components of physical fitness, and we need to briefly define each and clarify its role.

Strength is the capacity of a muscle to exert a force against resistance. Strength contributes to power and speed and is of great importance to a majority of sportspeople.

Muscular Endurance is the capacity to exert a force repeatedly over a period of time, e.g. it is the capacity of your legs to carry you 10 Km without stopping.

Flexibility is the range of motion about a joint. Improving flexibility involves the stretching of muscles and tendons to maintain or increase suppleness and provides increased resistance to muscle injury or soreness.

Cardio-Respiratory Endurance is the most essential component of physical fitness. It is the efficient functioning of the heart and lungs

AEROBIC FITNESS

The largest amount of oxygen that you can use per minute during exercise is called your maximum oxygen uptake (MVo₂). This is often referred to as your aerobic capacity.

The effort that you can exert over a prolonged period of time is limited by your ability to deliver oxygen to the working muscles. Regular vigorous exercise produces a training effect that can increase your aerobic capacity by as much as 20 to 30%. An increased MVO₂ indicates an increased ability of the heart to pump blood, of the lungs to ventilate oxygen and of the muscles to take up oxygen.

Anaerobic Training

This means "without oxygen" and is the output of energy when the oxygen supply is insufficient to meet the body's long-term energy demands. (For example, 100-meter sprint).

The Training Threshold

This is the minimum level of exercise which is required to produce significant improvements in any physical fitness parameter.

Progression

As you become fitter, a higher intensity of exercise is required to create an overload and therefore provide continued improvement

Overload

This is where you exercise at a level above that which can be carried out comfortably. The intensity, duration and frequency of exercise should be above the training threshold and should be gradually increased as the body adapts to the increasing demands. As your fitness level improves, so the training threshold should be raised.

Working through your program and gradually increasing the overload factor is important.

Specificity

Different forms of exercise produce different results. The type of exercise that is carried out is specific both to the muscle groups being used and to the energy source involved.

There is little transfer of the effects of exercise, i.e. from strength training to cardiovascular fitness. That is why it is important to have an exercise program tailored to your specific needs.

Reversibility

If you stop exercising or do not do your program often enough, you will lose the benefits you have gained. Regular workouts are the key to success.

WARM-UP

Every exercise program should start with a warm-up where the body is prepared for the effort to come. It should be gentle and preferably use the muscles to be involved later.

Stretching should be included in both your warm-up and cool-down and should be performed after 3-5 minutes of low-intensity aerobic activity or callisthenic type exercise.

Warm Down or Cool Down

This involves a gradual decrease in the intensity of the exercise session. Following exercise, a large supply of blood remains in the working muscles. If it is not returned promptly to the central circulation, pooling of blood may occur in the muscles

Heart Rate

As you exercise, so the rate at which your heartbeat also increases. This is often used as a measure of the required intensity of exercise. You need to exercise hard enough to condition your circulatory system and increase your pulse rate, but not enough to strain your heart.

Your initial level of fitness is important in developing an exercise program for you. If you are starting off, you can get a good training effect with a heart rate of 110-120 beats per minute (BPM). If you are fitter, you will need a higher threshold of stimulation.

To begin with, you should exercise at a level that elevates your heart rate to about 65 to 70% of your maximum. If you find this is too easy, you may want to increase it, but it is better to lean on the conservative side.

As a rule of thumb, the maximum heart rate is 220 minus your age. As you increase in age, so your heart, like other muscles, loses some of its efficiency. Some of its natural loss is won back as fitness improves.

The following table is a guide to those who are "starting fitness."

Age	25	30	35	40	45	50	55	60	65
Target heart Rate									
10 Second Count	23	22	22	21	20	19	19	18	18
Beats per Minute	138	132	132	126	120	114	114	108	108

Pulse Count

The pulse count (on your wrist or carotid artery in the neck, taken with two index fingers) is done for ten seconds, taken a few seconds after you stop exercising. This is for two reasons: (a) 10 seconds is long enough for accuracy, (b) the pulse count is to approximate your BPM rate at the time you are exercising. Since heart rate slows as you recover, a longer count isn't as accurate.

The target is not a magic number but a general guide. If you're above average fitness, you may work quite comfortably, a little above that suggested for your age group.

The following table is a guide to those who are keeping fit. Here we are working at about 80% of maximum.

Age	25	30	35	40	45	50	55	60	65
Target heart Rate									
10 Second Count	26	26	25	24	23	22	22	21	20
Beats per Minute	156	156	150	144	138	132	132	126	120

Don't push yourself too hard to reach the figures on this table. It can be very uncomfortable if you overdo it. Let it happen naturally as you work through your program. Remember, the target is a guide, not a rule; a little above or below is just fine.

Two final comments:(1) don't be concerned with day-to-day variations in your pulse rate; being under pressure or not enough sleep can affect it;(2) your pulse rate is a guide, don't become a slave to it.

ENDURANCE CIRCUIT TRAINING

Cardiovascular endurance, muscle, strength, flexibility and coordination are all necessary for maximum fitness. The principle behind circuit training is to give a person all the essentials at one time by going through your exercise program moving as fast as possible between each exercise. This increases the heart rate and sustains it, which improves the fitness level. Do not introduce this circuit training effect until you have reached an advanced program stage.

Body Building

Is often used synonymously with strength training. The fundamental principle here is OVERLOAD. Here, the muscle works against greater loads than usual. This can be done by increasing the load you are working against.

Patronization

This is the term used to vary your exercise program for both physiological and psychological benefits. In your overall program, you should vary the workload, frequency and intensity. The body responds better to variety, and so do you. In addition, when you feel yourself getting 'stale', bring in periods of lighter exercise to allow the body to recuperate and restore its reserves. You will enjoy your program more and feel better for it.

Muscle Soreness

For the first week or so, this may be the only indication you have that you are on an exercise program. This, of course, does depend on your overall fitness level. A confirmation that you are on the correct program is a very slight soreness in most major muscle groups. This is quite normal and will disappear in a matter of days.

If you experience major discomfort, you may be on a program that is too advanced, or you have increased your program too rapidly.

If you experience PAIN during or after exercise, your body is telling you something.

Stop exercising and consult your doctor.

WHAT TO WEAR

Wear clothing that will not restrict your movement in any way while exercising. Clothes should be light enough to allow the body to cool. Excessive clothing that causes you to perspire more than you normally would while exercising gives you no advantage. The extra weight you lose is body fluid and will be replaced with the next glass of water you drink. It is advisable to wear a pair of gym or running shoes or "sneakers."

Breathing During Exercise

Do not hold your breath while exercising. Breathe normally as much as possible. Remember, breathing involves the intake and distribution of oxygen, which feeds the working muscles.

Rest periods

Once you start your exercise program, you should continue through to the end. Do not break off halfway through and then restart at the same place later on without going through the warm-up stage again.

The rest period required between strength training exercises may vary from person to person. This will depend mostly on your level of fitness and the program you have chosen. Rest between exercises by all means, but do not allow this to exceed two minutes. Most people manage with half-minute to one-minute rest periods.

STRETCHING

Stretching should be included in both your warm-up and cool-down and should be performed after 3-5 minutes of low-intensity aerobic activity or callisthenic type exercise. Movements should be performed slowly and smoothly, with no bouncing or jerking. Move into the stretch until slight tension; not pain is felt in the muscle and hold for 20-30 seconds. Breathing should be slow, rhythmical and under control, making sure never to hold your breath.

HEAD ROLLS

Rotate your head to the right for one count, feeling the stretch up the left side of your neck. Next, rotate your head back for one count, stretching your chin to the ceiling and letting your mouth open. Rotate your head to the left for one count, and finally, drop your head to your chest for one count.

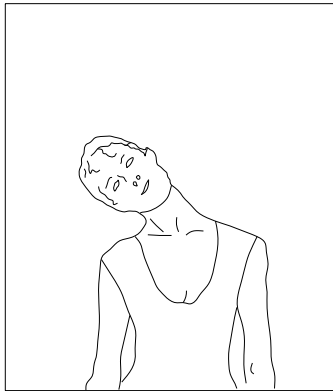

SHOULDER LIFTS

Lift your right shoulder up toward your ear for one count. Then lift your left shoulder up for one count as you lower your right shoulder.

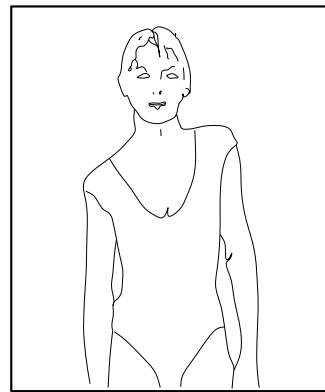

SIDE STRETCHES

Open your arms to the side and continue lifting them until they are over your head. Reach your right arm as far upward toward the ceiling as you can for one count. Feel the stretch up your right side. Repeat this action with your left arm.

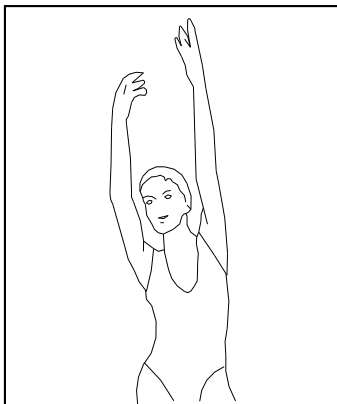

QUADRICEPS STRETCH

With one hand against a wall for balance, reach behind you and pull your right foot up. Bring your heel as close to your buttocks as possible. Hold for 15 counts and repeat with left foot up.

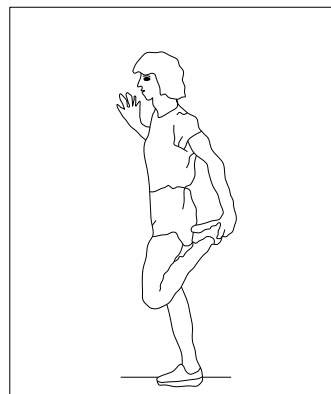

INNER THIGH STRETCH

Sit with the soles of your feet together with your knees pointing outward. Pull your feet as close into your groin as possible. Gently push your knees towards the floor. Hold for 15 counts.



TOUCHES

Slowly bend forward from your waist, letting your back and shoulders relax as you stretch toward your toes. Reach down as far as you can and hold for 15 counts.

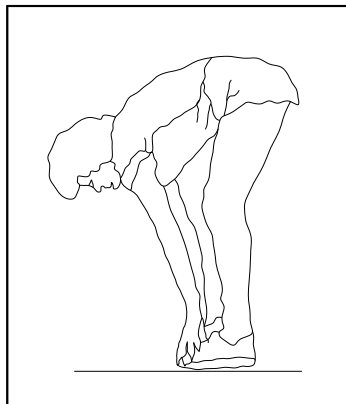

HAMSTRING STRETCHES

Sit with your right leg extended. Rest the sole of your left foot against your right inner thigh. Stretch as far as possible. Hold for 15 counts. Relax and then repeat with left leg extended.

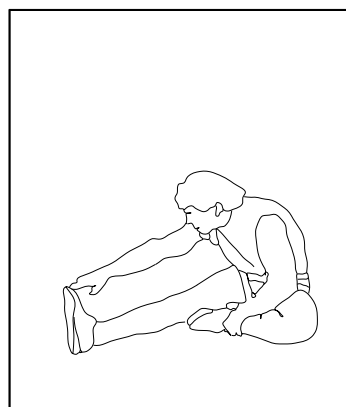

CALF / ACHILLES STRETCH

Lean against a wall with your left leg in front of the right and your arms forward. Keep toward your toe your right leg straight and the left foot on the floor then bend the left leg and lean forward by moving your hips toward the wall. Hold, then repeat on the other side for 15 counts.

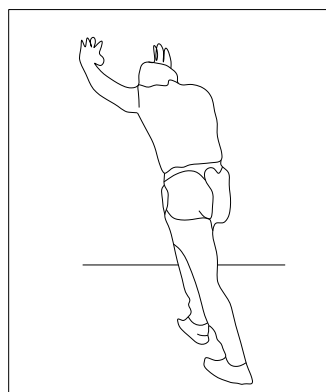

MANUFACTURER'S LIMITED WARRANTY

Dyaco Canada Inc. warrants all its Spirit treadmill for a period of time listed below, from the date of retail sale, as determined by a sales receipt. Dyaco Canada Inc.'s responsibilities include providing new or remanufactured parts at Dyaco Canada Inc.'s option and technical support to our independent dealers and servicing organizations. In the absence of a dealer or service organization, these warranties will be administered by Dyaco Canada Inc. directly to the facility. The warranty period applies to the following components:

Home Warranty		Light Commercial Warranty (Non-dues paying facility)	
Frame, Motor & Deck	Lifetime	Frame	Lifetime
Parts	10 Years	Motor, Deck & Parts	5 Years
Labour	2 Years	Labour	2 Years

This warranty is not transferable and is extended only to the original owner.

NORMAL RESPONSIBILITIES OF THE FACILITY

The facility is responsible for the items listed below:

1. The warranty registration can be completed online: Go to www.dyaco.ca/warranty.html and complete the online warranty registration.
2. Proper use of the treadmill in accordance with the instructions provided in this manual.
3. Proper installation in accordance with instructions provided with the treadmill and with all local electric codes.
4. Proper connection to a grounded power supply of sufficient voltage, replacement of blown fuses, repair of loose connections or defects in facility wiring.
5. Expenses for making the treadmill accessible for servicing, including any item that was not part of the treadmill at the time it was shipped from the factory.
6. Damages to the treadmill finish during shipping, installation or following installation.
7. Routine maintenance of this unit as specified in this manual.

EXCLUSIONS

This warranty does not cover the following:

1. **CONSEQUENTIAL, COLLATERAL, OR INCIDENTAL DAMAGES SUCH AS PROPERTY DAMAGE AND INCIDENTAL EXPENSES RESULTING FROM ANY BREACH OF THIS WRITTEN OR ANY IMPLIED WARRANTY.**
Note: Some areas do not allow the exclusion or limitation of incidental or consequential damages, so this limitation or exclusion may not apply to you.
2. Service call reimbursement to the facility. Service call reimbursement to the dealer that does not involve malfunction or defects in workmanship or material, for units that are beyond the warranty period, for units that are beyond the service call reimbursement period, for treadmill not requiring component replacement.
3. Damages caused by services performed by persons other than authorized Dyaco Canada Inc. service companies; use of parts other than original Dyaco Canada Inc. parts; or external causes such as corrosion, discoloration of paint or plastic, alterations, modifications, abuse, misuse, accident, improper maintenance, inadequate power supply, or acts of God.
4. Products with original serial numbers that have been removed or altered.
5. Products that have been: sold, transferred, bartered, or given to a third party.
6. Products that do not have a warranty registration card on file at Dyaco Canada Inc. Dyaco Canada Inc. reserves the right to request proof of purchase if no warranty record exists for the product.
7. **THIS WARRANTY IS EXPRESSLY IN LIEU OF ALL OTHER WARRANTIES EXPRESSED OR IMPLIED, INCLUDING THE WARRANTIES OF MERCHANTABILITY AND/OR FITNESS FOR A PARTICULAR PURPOSE.**
8. Warranties outside of Canada may vary. Please contact your local dealer or Dyaco Canada for details.

SERVICE

The sales receipt establishes the labour warranty period should service be required. If service is performed, it is in your best interest to obtain and keep all receipts. This written warranty gives you specific legal rights. Service under this warranty must be obtained by following these steps, in order:

1. Contact your selling authorized Spirit dealer or Dyaco Canada.
2. If you have any questions about your new product or questions about the warranty contact Dyaco Canada Inc. at 1-888-707-1880.
3. If no local service is available, Dyaco Canada Inc. will repair or replace the parts, at Dyaco Canada Inc.'s option, within the warranty period at no charge for parts. All transportation costs, both to our factory and upon return to the facility, are the responsibility of the facility. The facility is responsible for adequate packaging upon return to Dyaco Canada Inc. Dyaco Canada Inc. is not responsible for damages that occur during shipping. Make all freight damage claims with the appropriate freight carrier. **DO NOT SHIP ANY UNIT TO OUR FACTORY WITHOUT A RETURN AUTHORIZATION NUMBER.** All units arriving without a return authorization number will be refused.
4. For any further information, or to contact our service department by mail, send your correspondence to:

Dyaco Canada Inc.
5955 Don Murie Street
Niagara Falls, ON
L2G 0A9

Product features or specifications as described or illustrated are subject to change without notice. All warranties are made by Dyaco Canada.

dyaco

Please visit us online for information about our other brands and products manufactured and distributed by Dyaco Canada Inc.

SPIRIT

spiritfitness.ca

X XTEERRA
FITNESS

xterrafitness.ca

UFC

dyaco.ca/UFC/UFC-home.html

agio.
life begins
outdoors.

agiocanada.ca

SOLE
FITNESS

solefitness.ca

EVERLAST

dyaco.ca/everlast.html

Cikada

cikada.ca

TRAINOR
SPORTS

trainorsports.ca

For more information, please contact Dyaco Canada Inc.
T: 1-888-707-1880 | 5955 Don Murie St., Niagara Falls, Ontario L2G 0A9 | sales@dyaco.ca

Dyaco Canada Inc. dyaco.ca