

Owner's Manual

Model No.

16607302950US
XE295

- Assembly
- Operation
- Maintenance
- Parts
- Warranty

CAUTION:
Read and
understand this
manual before
operating unit

SPIRIT



Retain For Future Reference

Table Of Contents

Product Registration..... 3

Important Safety Instructions..... 4

Important Electrical Instructions 6

Important Operation Instructions 6

Assembly Instructions 8

Setting Up Your Elliptical 15

About Your Machine & Using the Spirit+ App..... 16

Operation of Your Console 17

Programmable Features..... 18

Programs Intro 20

Using A Heart Rate Transmitter (OPTIONAL)..... 30

Maintenance & Care..... 31

Exploded View Diagram 32

Parts List..... 33

Manufacturer’s Limited Warranty..... 37

ATTENTION
This elliptical is intended for residential use only and is warranted for this application. Any other application voids this warranty in its entirety.

Ver.A

SPIRIT

**CONGRATULATIONS ON YOUR
NEW ELLIPTICAL**

Thank you for your purchase of this quality elliptical from Dyaco Canada Inc. Your elliptical was manufactured by one of the leading fitness manufacturers in the world and is backed by one of the most comprehensive warranties available. Through your dealer, Dyaco Canada Inc. will do all we can to make your ownership experience as pleasant as possible for many years to come. The local dealership where you purchased this elliptical is your administrator for all warranty and service needs. Their responsibility is to provide you with the technical knowledge and service personnel to make your experience more informed and any difficulties easier to remedy.

Please take a moment at this time to record the name of the dealer, their telephone number, and the date of purchase below to make any future needed contact easy. We appreciate your support, and we will always remember that you are the reason that we are in business.

Please go to www.dyaco.ca/warranty and complete the online warranty registration.

Yours in Health,
Dyaco Canada Inc.

Name of Dealer _____

Dealer Phone # _____

Purchase Date _____

Product Registration

Please record the Serial Number of this fitness product in the space provided below.

Serial Number _____

REGISTER YOUR PURCHASE

Please visit us at www.dyaco.ca/warranty_to register your purchase.

Important Safety Instructions

When using an electrical appliance, basic precautions should always be followed, including the following:

WARNING - Read all instructions before using this appliance.

DANGER - To reduce the risk of electric shock disconnect your elliptical from the electrical outlet prior to cleaning and/or service work.

WARNING - To reduce the risk of burns, fire, electric shock, or injury to persons, install the elliptical on a flat level surface with access to a 115-volt, 15-amp grounded outlet with only the elliptical plugged into the circuit.

DO NOT USE AN EXTENSION CORD UNLESS IT IS A 14 AWG OR BETTER, WITH ONLY ONE OUTLET ON THE END:

WARNING !

- This exercise equipment is not intended for use by persons with reduced physical, sensory or mental capabilities, or lack of experience and knowledge.
- Use this appliance only for its intended use as described in this manual. Do not use attachments not recommended by the manufacturer.
- Never operate the appliance with the air openings blocked. Keep the air openings free of lint, hair, and the like.
- Never drop or insert any object into any openings.
- Do not use outdoors.
- The appliance is intended for household use.
- Do not operate elliptical trainer on deeply padded, plush or shag carpet. Damage to both carpet and elliptical trainer may result.
- Before beginning this or any exercise program, consult a physician.
- This is especially important for persons over the age of 35 or persons with pre-existing health conditions.
- Keep hands away from all moving parts.
- The pulse sensors are not medical devices. Their purpose is to provide you with an approximate measurement in relation to your target heart rate. Use of a chest transmitter strap (sold separately) is a much more accurate method of heart rate analysis. Various factors, including the user's movement, may affect the accuracy of heart rate readings. The pulse sensors are intended only as exercise aids in determining heart rate trends in general.
- Do not attempt to use your equipment for any purpose other than for the purpose it is intended.
- Wear proper shoes. High heels, dress shoes, sandals or bare feet are not suitable for use on your equipment. Quality athletic shoes are recommended to avoid leg fatigue.
- Never operate the elliptical trainer if any of the parts are damaged. If the elliptical trainer is not working properly, call your dealer.
- Do not operate where aerosol spray products are being used or where oxygen is being administered. Sparks from the motor may ignite a highly gaseous environment.

- Do not attempt to use your elliptical trainer for any purpose other than for the purpose it is intended. The hand pulse sensors are not medical devices. Their purpose is to provide you with an approximate measurement in relation to your target heart rate. Use of a chest transmitter strap is a much more accurate.
- Method of heart rate analysis. Various factors, including the user's movement, may affect the curacy of heart rate readings. The pulse sensors are intended only as exercise aids in determining heart rate trends in general.
- Keep children away from the elliptical trainer. There are obvious pinch points and other caution areas that can cause harm.
- **The Elliptical is not a medical device.**

Please ensure that you review and adhere to the user weight restrictions and power requirements of your new machine. Failure to do so may result in serious injury or damage to your machine.

SAVE THESE INSTRUCTIONS - THINK SAFETY!

Important Electrical Instructions

WARNING!

Route the power cord away from any moving part of the unit including the transport wheels.

NEVER remove any cover without first disconnecting AC power. If voltage varies by ten percent (10%) or more, the performance of your unit may be affected. **Such conditions are not covered under your warranty.** If you suspect the voltage is low, contact your local power company or a licensed electrician for proper testing.

NEVER expose this unit to rain or moisture. This product is **NOT** designed for use outdoors, near a pool or spa, or in any other high humidity environment. The temperature specification is 40 degrees C, and humidity is 95%, noncondensing (no water drops forming on surfaces).

Optimally the unit should be the only device plugged into the circuit. Our units have surge suppressors built in to help avoid nuisance tripping. We have tested several AFCI/GFCI breakers and outlets with our products. Brands we have tested are: Eaton (Cutler Hammer Series), Leviton (Smart lock pro) and Schneider Electric (Canadian home series). These breakers do not trip in our testing, when connected to our units, as long as no other devices are plugged into the same circuit.

Important Operation Instructions

- **NEVER** operate this elliptical without reading and completely understanding the results of any operational change you request from the computer.
- Understand that changes in resistance do not occur immediately. Set your desired resistance level on the computer console and release the adjustment key. The computer will obey the command gradually.
- **NEVER** use your elliptical during an electrical storm. Surges may occur in your household power supply that could damage elliptical components. Unplug the elliptical during an electrical storm as a precaution.
- Use caution while participating in other activities while pedaling on your elliptical; such as watching television, reading, etc. These distractions may cause you to lose balance which may result in serious injury.
- Do not use excessive pressure on console control keys. They are precision set to function properly with little finger pressure.

WARNING DECAL REPLACEMENT

The decal shown below has been placed on the bike. If the decal is missing or illegible, please call our Customer Service Department toll-free at 1-888-707-1880 to order a replacement decal.

⚠ WARNING / AVERTISSEMENT

Model/Modèle#: [REDACTED]
Serial#/Numéro de série: [REDACTED]

**For consumer use only.
Max user weight limit**
[REDACTED]

CAUTION-SMALL CHILDREN AND PERSONS PHYSICALLY HANDICAPPED SHOULD NOT USE ANY EXERCISE EQUIPMENT WITHOUT A QUALIFIED PERSON IN ATTENDANCE.
WARNING-KEEP CHILDREN AWAY FROM THE [REDACTED]
KEEP BODY AND CLOTHING FREE AND CLEAR OF ALL MOVING PARTS THE POSSIBILITY OF SERIOUS INJURIES OR DEATH IF CAUTION IS NOT USED.
READ ALL WARNINGS AND INSTRUCTIONS PRIOR TO USE. REPLACE LABEL IF DAMAGED, ILLEGIBLE OR REMOVED.

Usage à des fins personnelles seulement poids maximum de l'utilisateur
[REDACTED]

ATTENTION-LES ENFANTS ET LES PERSONNES AYANT UN HANDICAP PHYSIQUE NE DOIVENT UTILISER AUCUN APPAREIL D'EXERCICE SANS LA SURVEILLANCE D'UNE PERSONNE QUALIFIÉE.
AVERTISSEMENT: GARDER LES ENFANTS À L'ÉCART DU [REDACTED]. GARDER LE CORPS ET LES VÊTEMENTS ÉLOIGNÉS DE TOUTE PIÈCE MOBILE. LE DÉFAUT DE VIGILANCE DANS L'UTILISATION DE CET APPAREIL POURRAIT ENTRAÎNER DE GRAVES BLESSURES ET MÊME LA MORT.
LIRE TOUTS LES AVERTISSEMENTS ET TOUTES LES DIRECTIVES AVANT UTILISATION.
REPLACER TOUTE ÉTIQUETTE ENDOMMAGÉE, ILLISIBLE OU MANQUANTE.

Dyaco Canada Inc.
5955 Don Murie St
Niagara Falls, Ontario
L2G 0A9

Customer Service
Service à la clientèle
1-888-707-1880

Assembly Instructions

Pre-Assembly

1. Using a razor knife (Box Cutter), cut the banding straps that wrap around the carton. Reach under the bottom edge of the carton and pull it away from the cardboard underneath, separating the staples that join the two together. Lift the box over the unit and unpack.
2. Carefully remove all parts from carton and inspect for any damage or missing parts. If damaged parts are found, or parts are missing, contact your dealer immediately.
3. Locate the hardware package. The hardware is separated into four steps. Remove the tools first. Remove the hardware for each step as needed to avoid confusion. The numbers in the instructions that are in parenthesis (**#**) are the item number from the assembly drawing for reference.

Assembly Tools

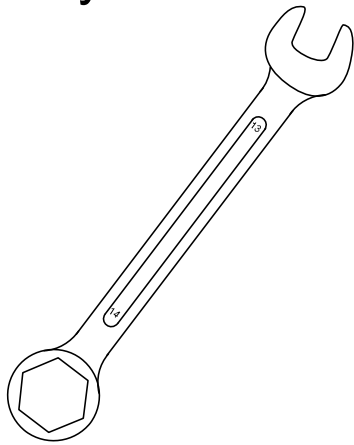

#155. 13/14mm Wrench (1 pc)

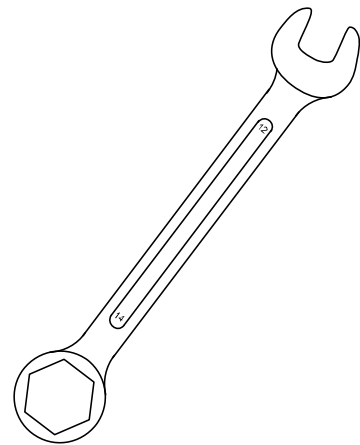

#158. 12/14mm Wrench (1 pc)

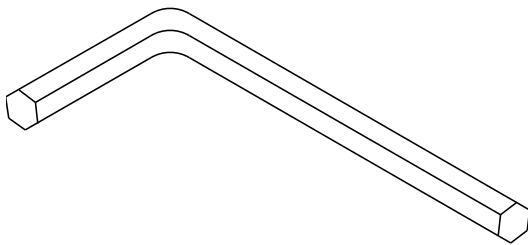

#177. L Allen Wrench (1 pc)

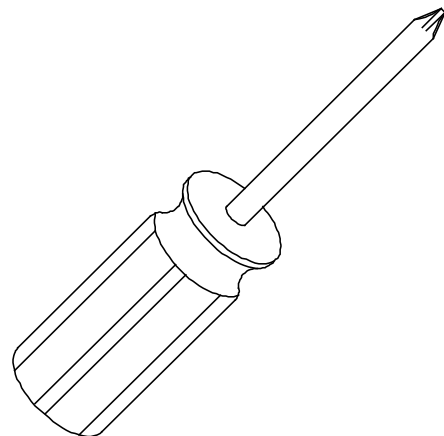

#157. Phillips Head Screwdriver (1 pc)

STEP 1

Gather **HARDWARE FOR STEP 1.**

1. Locate the **CONSOLE MAST (12)** and **CONSOLE MAST COVER (72)**; slide the Cover onto the Mast as far as it will go. Make sure the **CONSOLE MAST COVER (72)** is facing the correct way.
2. At the top opening of the **MAIN FRAME (1)**, there is a **COMPUTER CABLE (53)** tied to a twist tie wire. Feed the twist tie wire and **COMPUTER CABLE (53)** into the bottom of the **CONSOLE MAST (12)** and out of the opening at the top.
3. Install the **CONSOLE MAST (12)** into the receiving bracket on the top of the **MAIN FRAME (1)**. Be extremely careful not to pinch the cables between the tubing. If the cable gets pinched, this may affect the electrical functions of the console.
NOTE: There is one bolt already installed in the receiving bracket that will engage with the slot at the bottom of the Console Mast. This needs to be tightened last, after the three other console mast bolts.
Tighten 3 SHEET METAL SCREWS (120) on the CONSOLE MAST COVER (72/72-1) with the SCREW DRIVER (157).
4. Place a **SPLIT WASHER (152)** onto the **BOLT (105)** and hand tighten through the left side of the console mast. Place a **CURVED WASHER (153)** onto each **BOLT (103)** and thread both into the front of the console mast tube. Fasten these front bolts as tight as possible with the **WRENCH (155)**. Next firmly tighten the two left side bolts with the same wrench.
5. Connect the **2 HAND PULSE CABLES (47)**, **RESISTANCE CABLE (49)**, and **COMPUTER CABLE (53)** to the back of the **CONSOLE (43)**. Do not force the connectors; they will only fit one way and are different sizes to prevent confusion. Store the excessive cable in the **CONSOLE MAST TUBE (12)**.
6. Attach the **CONSOLE (43)** to the bracket of the Console Mast tube with **4 PHILLIPS HEAD SCREWS (116)**. Tighten the screws with the **PHILLIPS HEAD SCREW DRIVER (157)**.
7. Attach the **REAR RAIL ASSEMBLY** to the **RAILS (2)** with **2 BUTTON HEAD SOCKET BOLTS (130)** and **CURVED WASHERS (153)** on each side. Tighten using the **COMBINATION L ALLEN WRENCH (177)**.
8. Slide the Rail Assembly into the **MAIN FRAME (1)**. Insert one **BUTTON HEAD SOCKET BOLT (176)** through each side and attach a **FLAT WASHER (137)** and a **BOLT (130)** to each joint on the inside.
9. Insert **6 OVAL END CAPS (93)** into the **MAIN FRAME (1)**.

HARDWARE

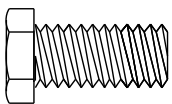

#103. 3/8" × 3/4"
Hex Head Bolt (2 pcs)

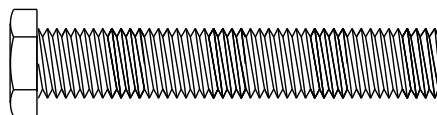

#105. 3/8" × 2-1/4"
Hex Head Bolt (1 pc)

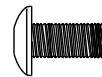

#116. M5 × 10m/m Phillips
Head Screw (4 pcs)

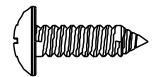

#120. 3.5 × 16m/m Sheet
Metal Screw (3 pcs)

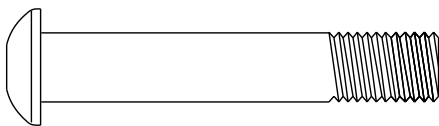

#176. 3/8" × 2-1/4" Button
Head Socket Bolt (2 pcs)

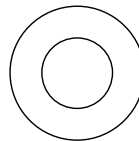

#137. 3/8" × 19 × 1.5T
Flat Washer (2 pcs)

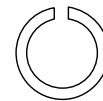

#152. 3/8" × 2T
Split Washer (1 pc)

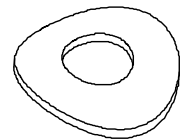

#153. 3/8" × 23 × 2T
Curved Washer (6 pcs)

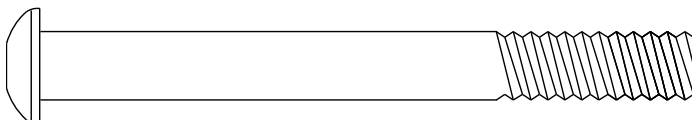

#130. 3/8" × 3-3/4" Button
Head Socket Bolt (4 pcs)

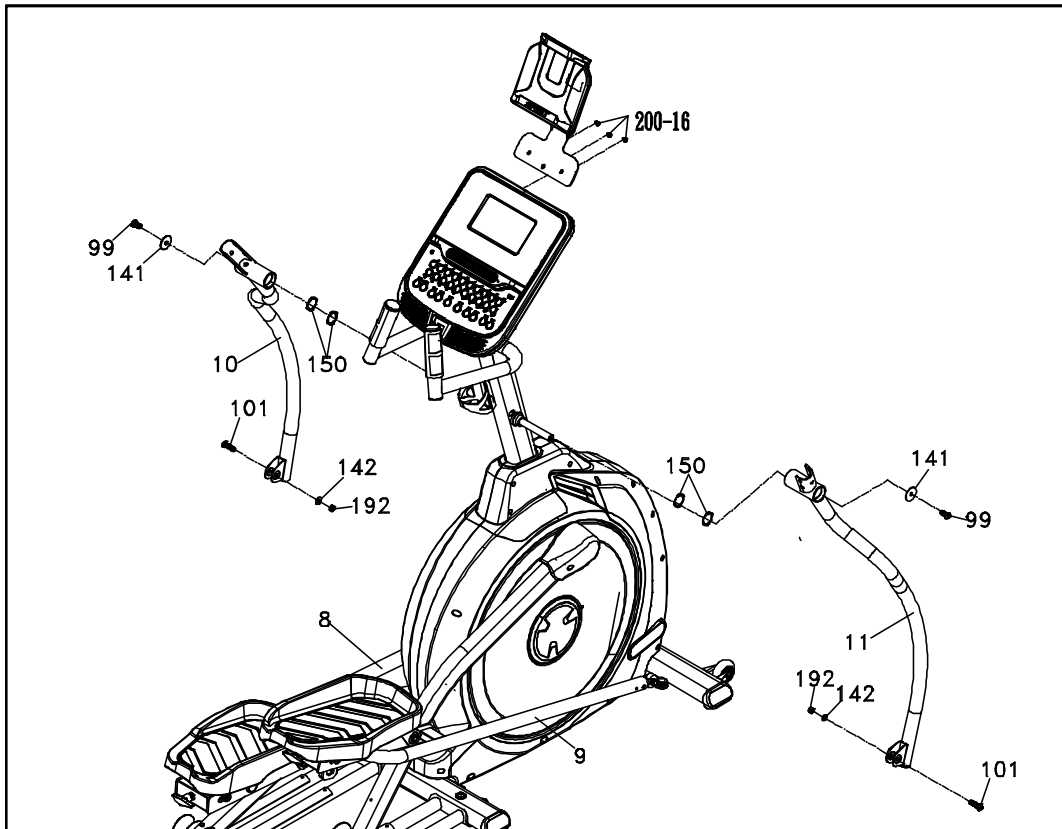

STEP 2

Gather **HARDWARE FOR STEP 2**.

1. Slide **2 WAVE WASHERS (150)** onto each side of the Swing Arm Axle. Slide the **LOWER SWING ARMS (10 LEFT, 11 RIGHT)** onto the axles and secure with the **2 HEX HEAD BOLTS (99)** and **FLAT WASHERS (141)**. Do not force the Swing Arms onto the axle. They should slide on, but you may need to jiggle them to get them lined up properly. The Swing Arms have been previously installed at the factory so they do fit properly.
2. Remove the tie that holds the spacer in the rod end located at the end of the **RIGHT CONNECTING ARM (9)** and line up the rod end with the bracket at the bottom of the **LOWER RIGHT SWING ARM (11)**. Slide the **HEX HEAD BOLT (101)** through the bracket of the Lower Swing Arm and then through the rod end and spacer. Install the **FLAT WASHER (142)** and **NYLON NUT (192)** on the bolt and tighten as much as possible.
3. Repeat this step for the left side. Tighten using the **WRENCHES (155 & 158)**.
4. Place **Tablet Holder (200)** on **Console Bottom Cover** and use **Phillips Head Screw Driver (157)** to tighten **3 Phillips Head Screw (200-16)**.

HARDWARE

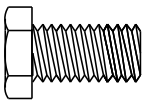

#99. 5/16" × 15mm
Hex Head Bolt (2 pcs)



#101. 5/16" × 1-1/4"
Hex Head Bolt (2 pcs)

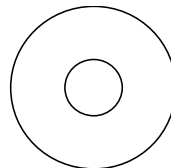

#141. 5/16" × 23 × 1.5T
Flat Washer (2 pcs)

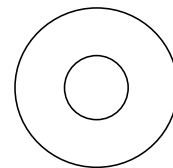

#142. 5/16" × 20 × 1.5T
Flat Washer (2 pcs)



#150. Ø 17 m/m
Wave Washer (4 pcs)
Customer Service 1-888-707-1880
Email: customerservice@dyaco.ca



#192. 5/16" × 9T
Nylon Nut (2 pcs)



#200-16. M5 × 12L
Phillips Head Screw (3 pcs)

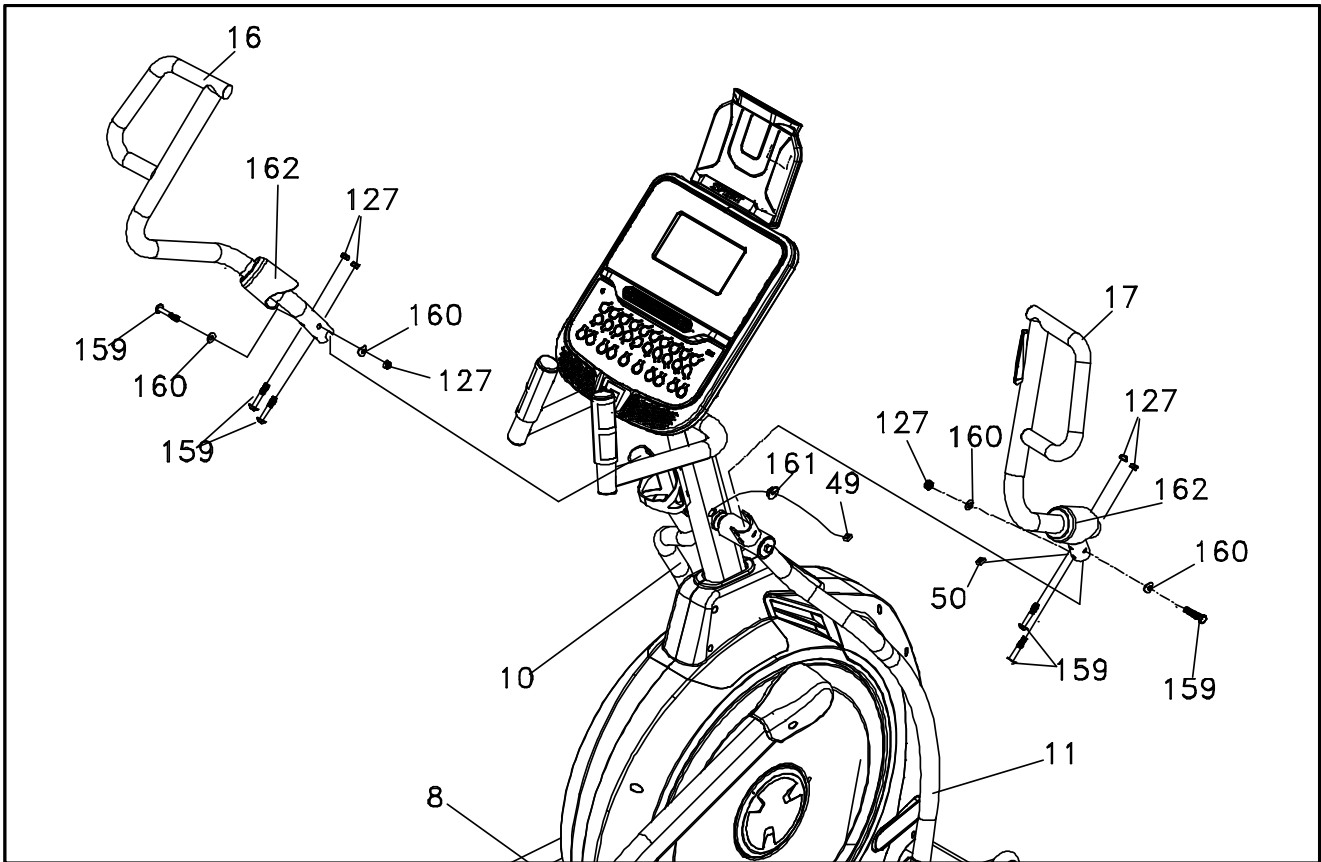

STEP 3

Gather **HARDWARE FOR STEP 3.**

1. Slide the **RUBBER SLEEVE (162)** onto the **LEFT (16)** and **RIGHT (17) UPPER SWING ARMS**. Make sure the wide part is at the bottom.
2. Attach the **WIRE (50)** from the **RIGHT UPPER SWING ARM (17)** to the **WIRE (49)** that exits the **CONSOLE MAST TUBE (12)**. Slide the **SWITCH WIRE CAP (161)** onto the wire with the wide side facing the Swing Arm.
3. Insert the **UPPER SWING ARM (17)** into the Lower Swing Arm. Fasten together with **3 HEX HEAD BOLTS (159)**, **2 CURVED WASHERS (160)**, and **3 NYLON NUTS (127)**.
4. Repeat # 3 from above on the left side.

HARDWARE



#127. 5/16" × 7T
Nylon Nut (6 pcs)

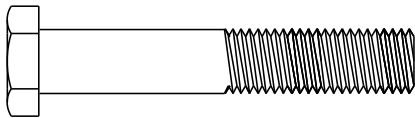

#159. 5/16" × 1-3/4"
Hex Head Bolt (6 pcs)

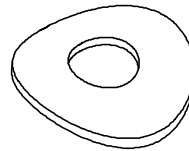

#160. 5/16" × 23 × 1.5T
Curved Washer (4 pcs)

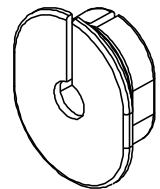

#161. Switch Wire
Cap (1 pcs)

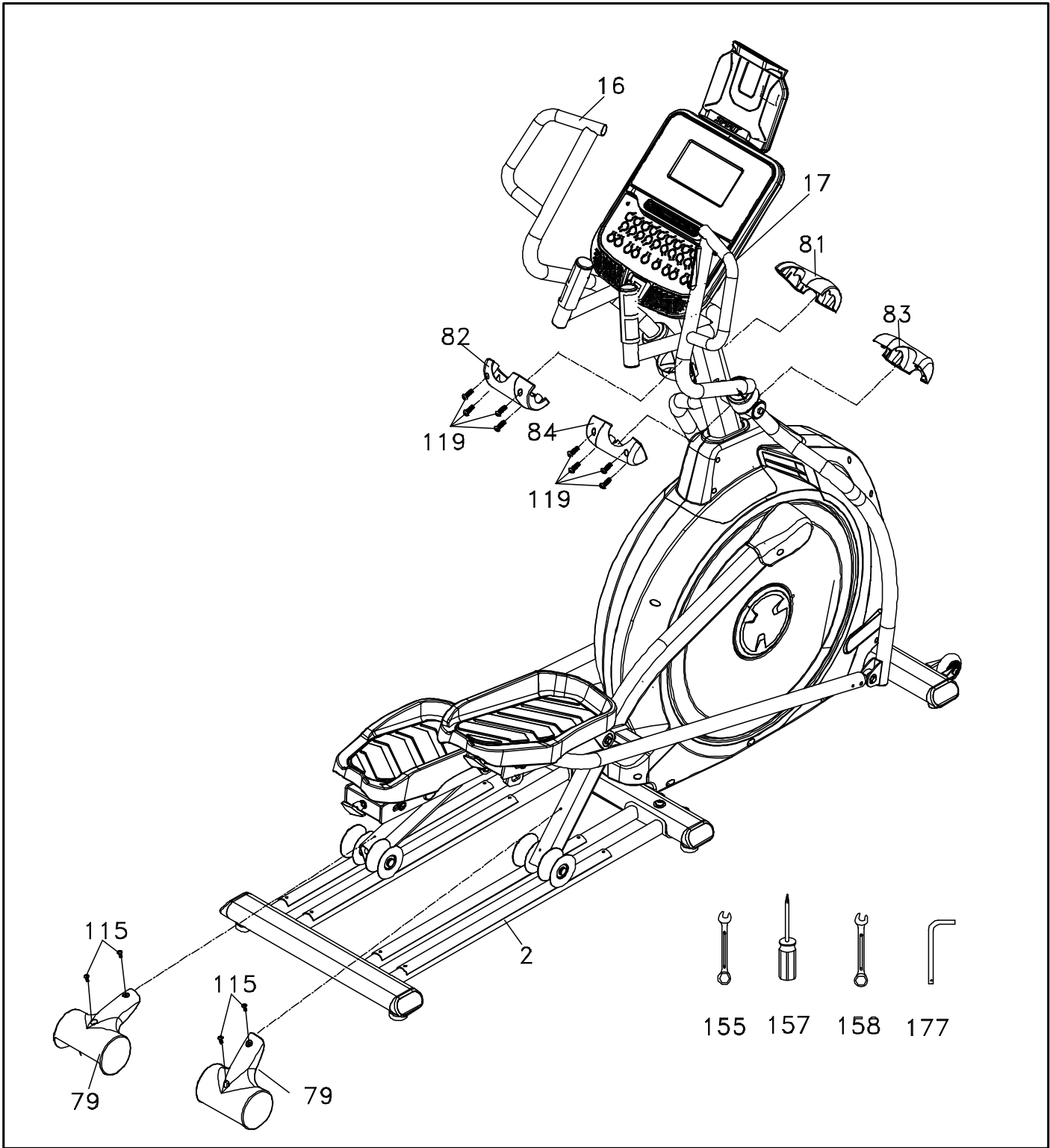

STEP 4

Gather **HARDWARE FOR STEP 4.**

1. Fasten the two **WHEEL COVERS (79)** to the rollers with **4 PHILLIPS HEAD SCREWS (115)**. Tighten with the **PHILLIPS HEAD SCREW DRIVER (157)**.
2. Install the **LEFT HANDLE BAR COVERS (81 & 82)** and **RIGHT HANDLE BAR COVERS (83 & 84)** over the Handle Bar axle connections with **4 SHEET METAL SCREWS (119)** on each side. Tighten with the **PHILLIPS HEAD SCREW DRIVER (157)**.
3. Look closely at the four floor levelers underneath the middle and rear of the elliptical. If any of these aren't in contact with the floor, use the **WRENCH (109)** to loosen the bottom nut. Once the nut has been loosened, turn the rubber caster clockwise until it makes solid contact with the floor. Retighten the bottom nut to prevent it from moving.

HARDWARE

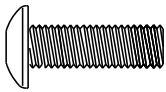

#115. M5 × 12L Phillips
Head Screw (4 pcs)



#119. 3.5 × 12mm
Sheet Metal Screw (8 pcs)

Setting Up Your Elliptical

Notice About Pedals

The foot plates on your new elliptical have a pull-pin adjustment. This adjustment allows you to change the angle of the footpad to add variety to your workouts. The foot plates are spring loaded, and when the pull-pin is pulled, the foot plate can drop suddenly. To avoid any injury please do not put your hand, or any other body part, under the foot plate when pulling the pull-pin. Only place your hand under the very rear of the foot plate, just above the pull-pin.



Moving The Elliptical

Holding the Rear Stabilizer, gently tilt the elliptical up and roll it away.

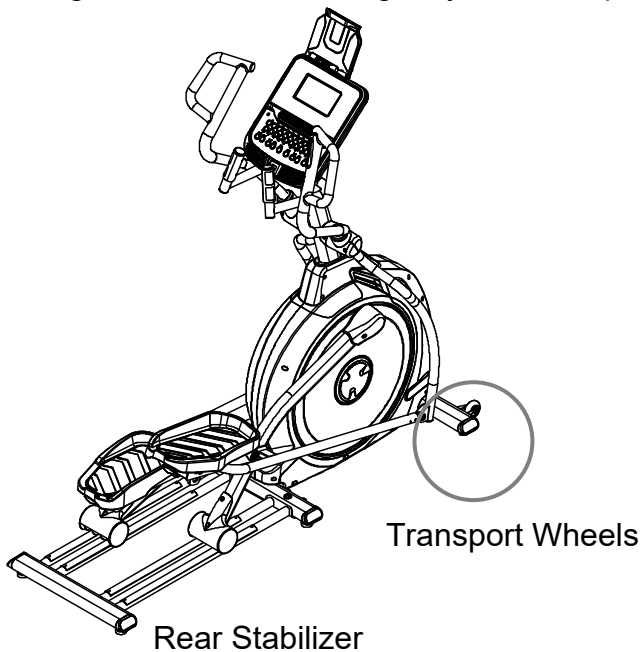

ABOUT YOUR MACHINE

Always use care and caution when operating your machine. Follow instruction in this manual to ensure safe operation and maintenance of your Elliptical.

Your new Spirit Fitness Elliptical has Bluetooth connectivity to give you access to the most advanced workout experiences available. Follow the instructions as below to learn more about using the Bluetooth capabilities to their fullest potential.



Downloading the Spirit+ app will help unlock more features- such as tracking workouts and sharing data via Google Fit and Apple Fitness. Simply search for “Spirit+” in the app store on your smartphone or tablet, or scan the QR code as below.

Did you know that you can personalize your experience with your new Elliptical? Create a profile and save custom work- out programs by following the instructions as below.

USING THE SPIRIT+ APP

In order to help you achieve your exercise goals, your new exercise machine comes equipped with a Bluetooth® transceiver that will allow it to interact with selected phones or tablet computers via the Spirit+ App. Just download the free Spirit+ App from the Apple Store or Google Play, and then follow the instructions in the App to sync with your exercise machine.

Press the “DISPLAY” button from the APP to view the display of the current workout data. When your exercise is complete, choose “END & SAVE WORKOUT” to store the workout data. The Spirit + App also allows you to sync your workout data with one of many fitness cloud sites we support: Apple Health, Google Fit, MapMyFitness or Fitbit, with more to come.

1. Download the App by scanning the QR code on the right.
2. Open the App on your device (phone or tablet) and make sure Bluetooth® is enabled on your device (phone or tablet).
3. In the App click the Bluetooth® icon to search for your Spirit + equipment.
4. Under the Bluetooth® scan result list, select the machine for connect. When the App and equipment are synced, the Bluetooth® icon on the equipment’s console display will light up. Click “DISPLAY”, you may now start using your Spirit + App.
5. When your exercise is complete, choose “END & SAVE WORKOUT” to store the workout data. You will be prompted to sync your data with each available fitness cloud site. Please note, you will have to download the applicable compatible fitness App, such as Apple Health, Google Fit, MapMyFitness, Fitbit, etc., in order for the icon to be active and available.

Note: Your device will need to be running on a minimum operating system of IOS 13.1 or Android 8.0 for the spirit + App to operate properly.

The exercise equipment can also play music wirelessly via Bluetooth®. Turn on your mobile phone or tablet’s Bluetooth® function. Search for the name “Bt-speaker” in your device’s Bluetooth® menu. Tap to connect. Now your device can transmit music to the exercise equipment.



Operation of Your Console

GETTING FAMILIAR WITH THE CONTROL PANEL



Powering On

When the power cord is connected to the equipment, the console will automatically Power up.

When initially powered on the console will perform an internal self-test. During this time all the lights will turn on. When the lights go off, the Message Center will show the software version (i.e.:VER 1.0). The distance window shows the distance in kilometers or miles and the time window shows the total hours of use.

The odometer will remain displayed for only a few seconds then the console will go to the start up display. The dot matrix display will be scrolling through the different profiles of the programs and the Message Center will be scrolling the start up message. You may now begin to use the console.

Quick Start

1. This is the quickest way to start a workout. After the console powers up you just press the **Start** key to begin, this will initiate the Quick Start mode. In Quick Start the Time will count up from zero and the workload may be adjusted manually by pressing the **Level +/- keys**. The dot matrix display will have only the bottom row lit at first. As you increase the work load more rows will light indicating a harder workout. The elliptical will get harder to pedal as the rows increase.
2. There are 20 levels of resistance available for plenty of variety. The first 5 levels are very easy workloads and the changes between levels are set to a good progression for de-conditioned users. Levels 6-10 are more challenging, but the increases in resistance from one level to the next remain small. Levels 11-15 start getting tough as the levels jump more dramatically. Levels 16-20 are extremely difficult and are good for short interval peaks and elite athletic training.

FEATURES

Basic Information

The **Stop** key actually has several functions. Pressing the **Stop** key once during a program will pause the program for 5 minutes. If you need to get a drink, answer the phone or any of the many things that could interrupt your workout, this is a great feature. To resume your workout during **Pause**, just press the **Start** key. If the **Stop** key is pressed twice during a workout, the program will end and the console will display your Workout Summary (Total time, Avg. Speed, Avg. Watts, Avg. HR, total Laps). If the **Stop** key is held down for 3 seconds or a third time during the program, the console will perform a complete **Reset**. During data entry for a program the **Stop** key performs a previous screen or segment function. This allows you to go back to change programming data.

Program Key

The Program Key is used to preview each program. When you first turn the console on you may press the program key to preview what the program profile looks like.

Heart Rate Monitoring

The Elliptical has a built in heart rate monitoring system. Simply grasping the hand pulse sensors on the stationary handle bars or wearing the heart rate transmitter (see Using Heart Rate Transmitter section) will start the Heart Icon blinking (this may take a few seconds). The Pulse Display Window will display your heart rate, or Pulse in beats per minute.

Built-in Fan

The console includes a built-in fan to help keep you cool. To turn the fan on, press the button on the left side of the console.

Child Lock

Your machine is equipped with a child lock feature which disables the buttons on the console to prevent unauthorized use. To turn on, press **Child Lock**, then LED will light up. The elliptical will be in idle mode and cannot be operated. You must hold **Child Lock** for 3 seconds to unlock. After the LED light turns off, then press **START** to operate.

Charge Portable Devices with USB port

Charge your personal device during your workout using the fitness equipment's on-console USB port. To charge your mobile electronics make sure the fitness equipment power is on.

Step 1: Connect your USB charging cable (not included) to the USB Power Port and to your device.

Step 2: Check to make sure your device icon indicates it is charging.

NOTE:

- USB charging cable is not included, make sure compatible USB charging cable is being used.
- The USB port on the console is capable of powering USB devices. It provides up to 5Vdc/1.0 amp of power and meets USB 2.0 regulations. You will not be able to save your workout data to a USB via this port; it is used for charging purposes only.



Calorie Display

Displays the cumulative calories burned at any given time during your workout.

Note: This is only a rough guide used for comparison of different exercise sessions, and is not to be used for medical purposes.

Direct Resistance Buttons

You are able to set your resistance level quickly by pressing the buttons on the console. Simply choose the desired level of resistance from the console and the Elliptical will automatically adjust to that level. This saves time because you don't have to press and hold or hold a button down until reaching the desired value.

Pulse Grip Feature

The Pulse (Heart Rate) console window will display your current heart rate in beats per minute during the workout. You must use both stainless steel sensors on the front cross bar or the heart rate transmitter chest strap to display your pulse. Pulse value displays anytime the upper display is receiving a Pulse signal. You may not use the Grip Pulse feature while in Heart Rate Programs.

Programs Intro

Programming the Console

Each of the programs can be customized with your personal information and changed to suit your needs. Some of the information asked for is necessary to ensure the readouts are correct. You will be asked for your Age and Weight. Entering your Age is necessary during the Heart Rate programs to ensure the correct settings are in the program for your Age. Your weight is used to give a more accurate calorie count.

CALORIE NOTE: Calorie readings on every piece of exercise equipment, whether it is in a gym or at home, are not accurate and tend to vary widely. They are meant only as a guide to monitor your progress from workout to workout. The only way to measure your calorie burn accurately is in a clinical setting connected to a host of machines. This is because every person is different and burns calories at a different rate. Some good news is that you will continue to burn calories at an accelerated rate for at least an hour after you have finished exercising!

Entering a Program and Changing Settings

When you enter a program, by pressing the **Program** key, then **Enter** key, you have the option of entering your own personal settings. If you want to workout without entering new settings, then just press the **Start** key. This will bypass the programming of data and take you directly to the start of your workout. If you want to change the personal settings then just follow the instructions in the Message Center. If you start a program without changing the settings, the default or saved settings will be used.

NOTE: Age and Weight default settings will change when you enter a new number. So the last Age and Weight entered will be saved as the new default settings. If you enter your Age and Weight the first time you use the elliptical trainer, you will not have to enter it every time you work out unless either your Age or Weight changes or someone else enters a different Age and Weight.

PROGRAMS - TO SELECT AND START A PROGRAM

Preset

1. Press **PROGRAM** key to select the desired program button, then press the **Enter** key.
2. The Message Center will ask you to enter your Age.
You may adjust the age setting, using the **+ and -**-keys, then press the **Enter** key to accept the new number and proceed on to the next screen.
3. You are now asked to enter your Weight. You may adjust the weight number using the **+ and -** keys, then press **Enter** to continue.
4. Next is Time. You may adjust the Time and press **Enter** to continue.
5. Now you are asked to adjust the Max Resistance Level.
This is the peak exertion level you will experience during the program (at the top of the hill). Adjust the level and then press **Enter**.
6. Now you are finished editing the settings and can begin your workout by pressing the **Start** key.
7. If you want to increase or decrease the workload at any time during the program press the **+ or -** key.
8. During the program you will be able to scroll through the data in the Message Center by pressing the **Enter** key.
9. When the program ends the Message Center will show a summary of your workout. The summary will be displayed for a short time then the console will return to the start- up display.

Manual

The Manual program works as the name implies, manually. This means that you control the workload and not the computer. To start the Manual program, follow the instructions below.

1. Press **PROGRAM** key to select Manual, then press the **Enter** key.
2. The Message Center will ask you to enter your Age. You may enter your age, using the **Level +/- keys**, then press the **Enter** key to accept the new value and proceed on to the next screen.
3. You are now asked to enter your Weight. You may adjust the Weight value using the **Level +/- keys**, then press **Enter** to continue.
4. Next is Time. You may adjust the Time and press **Enter** to continue.
5. Now you are finished editing the settings and can begin your workout by pressing the **Start** key. You can also go back and modify your settings by pressing the **Enter** key.
6. Once the program starts you will be at level one. This is the easiest level and it is a good idea to stay at level one for a while to warm up. If you want to increase the work load at any time press the **Level + key**; the **Level - key** will decrease the workload.
7. During the Manual program you will be able to scroll through the data in the Message Center by pressing the **Enter** key.
8. When the program ends you may press **Start** to begin the same program again or **Stop** to exit the program.

PROGRAMS - PRESET

The Elliptical has multiple different programs that have been designed for a variety of workouts. These eight programs have factory preset work level profiles for achieving different goals.

HILL

This program follows a triangle or pyramid type of gradual progression from approximately 10% of maximum effort (the level that you chose before starting this program) up to a maximum effort which lasts for 10% of the total workout time, then a gradual regression of resistance back to approximately 10% of maximum effort

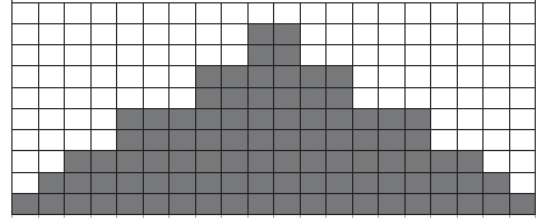

FAT BURN

This program follows a quick progression up to the maximum resistance level (default or user input level) that is sustained for 2/3 of the workout. This program will challenge your ability to sustain your energy output for an extended period of time.

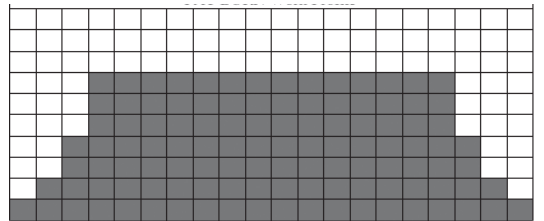

CARDIO

This program presents a quick progression up to near maximum resistance level (default or user input level). It has slight fluctuations up and down to allow your heart rate to elevate, and then recover repeatedly, before beginning a quick cool down. This will build up your heart muscle and increase blood flow and lung capacity.

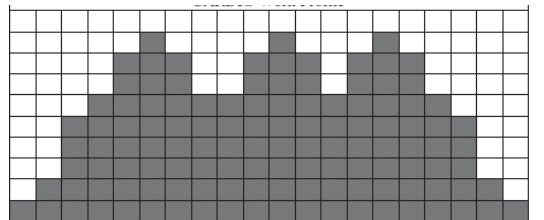

STRENGTH

This program has a gradual progression of resistance up to 100% of maximum effort that is sustained for 25% of workout duration. This will help build strength and muscular endurance in the lower body and glutes. A brief cool down follows.

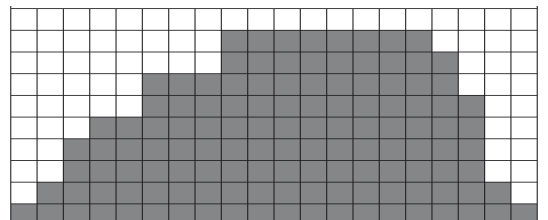

HIIT

This program takes you through high levels of intensity followed by recovery periods of low intensity. This program utilizes and develops your “Fast Twitch” muscle fibers which are used when performing tasks that are intense and short in duration. These deplete your oxygen level and spike your heart rate, followed by periods of recovery and heart rate drop to replenish oxygen. Your cardiovascular system gets programmed to use oxygen more efficiently.

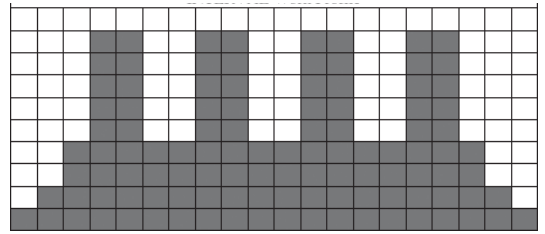

FUSION

This program takes you through high levels of cardio & strength intensity followed by recovery periods of low intensity. This program utilizes and develops your “Fast Twitch” muscle fibers which are used when performing tasks that are intense and short in duration. These deplete your oxygen level and spike your heart rate, followed by periods of recovery and heart rate drop to replenish oxygen. Your cardiovascular system gets programmed to use oxygen more efficiently.

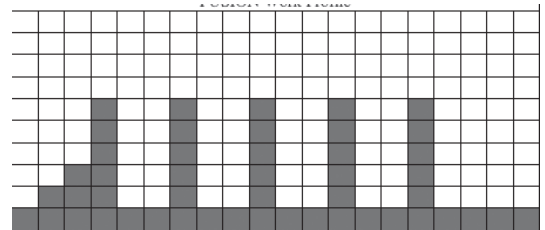

PROGRAMS

Fusion

In this interval program you will alternate between mid-high intensity cardiovascular intervals on the Elliptical, strength exercises off of the Elliptical, and low intensity recovery intervals on the Elliptical. You will need a pair of objects that can be comfortably held in your hands (dumbbells, water jugs, soup cans, etc.) for 4 of the 5 strength exercises performed in this program.

1. Press **PROGRAM** key to select Fusion program button, then press the **Enter** key.
2. If Enter was pressed, the Message center will now be blinking a value, indicating your Age (default is 35). Use the **Level +/- keys** to adjust, then press **Enter**. Your age determines your recommended maximum heart rate. Since the Bar Graph Display and the Heart Rate features are based on a percentage of your maximum heart rate, it is important to enter the correct age for these features to work properly.
3. The Message Center will now be blinking a value, indicating your Body Weight. Entering the correct body weight will affect the calorie count. Use the **Level +/- keys** to adjust, then press **Enter**.

Note about the Calorie display: No exercise machine can give you an exact calorie count because there are too many factors which determine exact calorie burn for a particular person. Even if someone is the exact same body weight, age and height, their calorie burn may be very different than yours. The Calorie display is to be used as a reference only to monitor improvement from workout to workout. The calorie count displayed in this program won't be accurate because the machine can't calculate calories expended while strength training.

4. The Message Center will now be blinking the preset top Resistance level of the selected program (default/mini- mum resistance is Level 5). Use the **Level +/- keys** to adjust, then press **Enter**. This value will be the Level for all cardio intervals. The resistance level can be adjusted at any time during the program.
5. The Message Center will be blinking the number of intervals desired (default is 10); you may select 10 (5 cardio & 5 strength), 20 (10 cardio & 10 strength), or 30 (15 cardio & 15 strength). Use the **Level +/- keys** to adjust, then press **Enter**.
6. The Message Center will be blinking the desired Interval time (default is 2:00).The time you select will be the duration of each cardio interval. Note: As a general rule, the longer the interval, the less resistance (fitness Elliptical) is required and the more repetitions you perform, the less weight (dumbbells) you need to use; use the **Level +/- keys** to adjust, then press **Enter**.
7. The Message Center will be blinking the recover y time you desire (default is 0:30) after completing both the cardio & strength intervals. Use the **Level +/- keys** to adjust, then press **Enter**.

CAUTION: The shorter the recovery time, the longer your heart rate will stay elevated; if you are new to exercise or have recently resumed an exercise program after a considerable amount of time off, it is recommended that your recovery interval length either matches or exceeds the length of the cardio interval.

Custom Workout Program

There are two customizable User programs that allow you to build and save your own workout. The two programs, Custom 1 and Custom 2, operate exactly the same way so there is no reason to describe them separately. You can build your own custom program by following the instructions below or you can save any other preset program you complete as a custom program. Both programs allow you to further personalize it by adding your name.

1. Press **PROGRAM** key to select Custom program button (Custom 1 or Custom 2), then press the **Enter** key. If you have already saved a program to either Custom 1 or Custom 2, it will be displayed and you are ready to begin. If not, you will have the option of inputting a username. In the Message Window, the letter "A" will be blinking. Use the **Level +/-** buttons to select the appropriate first letter of your name (pressing the **LEVEL +/-** button will switch to the letter "B"; pressing the Down button will switch to letter "Z"). Press **Enter** when the desired letter is displayed. Repeat this process until all of the characters of your name have been programmed (maximum 7 characters). When finished press **Stop**.
2. If there is a program already stored in Custom when you press the key, you will have an option to run the program as it is or delete the program and build a new one. At the welcome message screen, when pressing **Start or Enter** you will be prompted: Run Program? Use the **Level +/-** to select Yes or No. If you select No, you will then be asked if you want to delete the currently saved program. It is necessary to delete the current program if you want to build a new one. The Message Center will ask you to enter your Age. You may enter your age, using the **Level +/-** keys, then press the **Enter** key to accept the new value and proceed on to the next screen.
3. The Message Center will ask you to enter your Age. You may enter your age, using the **Level +/-** keys, then press the **Enter** key to accept the new value and proceed on to the next screen.
4. You are now asked to enter your Weight. You may adjust the weight value using the **Level +/-** keys, then press **Enter** to continue.
5. Next is Time. You may adjust the time and press **Enter** to continue.
6. Now the first column will be blinking and you are asked to adjust the resistance level for the first segment (SEGMENT> 1) of the workout by using the **Level +/-** key. When you finish adjusting the first segment, or if you don't want to change, then press **Enter** to continue to the next segment.
7. The next segment will show the same workload resistance level as the previously adjusted segment. Repeat the same process as the last segment then press **Enter**. Continue this process until all twenty segments have been set.
8. Now you are finished editing the settings and can begin your workout by pressing the **Start** key. You can also go back and modify your settings by pressing the **Enter** key.

5K or 10K Program

5K Run, 10K Run programs automatically set a target distance for your workout (5 km and 10 km, respectively). When the program begins the Distance will count down; once it reaches zero the program ends. Program ends when the target distance is reached.

*Please note that the Speed readout is in MPH if the console is not set to Metric readings.

1. Press **PROGRAM** key to select the 5K or 10K program.
Press **Enter** to set the program. The display will prompt you through the programming or you can just press Start to begin the program with default values.
2. If **Enter** was pressed, the Message center will now be blinking a value, indicating your Age (default is 35). Use the **+ or –** keys to adjust, then press **Enter**.
3. The Message center will now be blinking a value, indicating your Body Weight (default is 155 lbs/ 70kgs.). Use the **+ or –** keys to adjust, then press **Enter**.
4. You are now done programming data and may press **Start** to begin your workout or **Stop** to go back one level to change data entered in the programming phase.

Countdown Mode

Target programs can be set a **Target Time, Target Distance or Target Calories** for your workout. When the program begins the target item will count down; once it reaches zero the program ends.

1. Press **PROGRAM** key to select TARGET PROGRAM, then press **Enter**.
2. Press **PROGRAM** key to select the Target Time program, Target Distance program or Target Calories program. Press **Enter** to set the program. The display will prompt you through the programming or you can just press **Start** to begin the program with default values.
3. If **Enter** was pressed, the **Message center** will now be blinking a value, indicating your Age (default is 35). Use the **+ or –** keys to adjust, then press **Enter**.
4. The Message center will now be blinking a value, indicating your **Body Weight** (default is 155 lbs/ 70kgs.). Entering the correct body weight will affect the calorie count. Use the **+ or –** keys to adjust, then press **Enter**.

A note about the Calorie display: No exercise machine can give you an exact calorie count because there are too many factors which determine exact calorie burn for a particular person. Even if someone is the exact same body weight, age and height, their calorie burn may be very different than yours. The Calorie display is to be used as a reference only to monitor improvement from workout to workout.

5. In Target Time program, the Message Center will be blinking a value, indicating **Time** (the default value is 5 minutes) In Target Distance program, the Message Center will be blinking a value, indicating **Distance** (the default value is 3.00 mile) In Target Calories program, the Message Center will be blinking a value, indicating **Calories** (the default value is 300). You may use any of the **+ or -** keys to adjust the target item. After adjusting, or to accept the default, press **Enter**.
6. You are now done programming data and may press **Start** to begin your workout.

Heart Rate Program Operation

Note: You must wear the heart rate transmitter strap for these programs. Both programs operate the same.

Heart Rate programs operate the same, the only difference is that **HR1** is set to 55%, **HR2** is set to 65%, **HR3** is set to 75% and **HR4** is set to 85% of the maximum heart rate. They are programmed the same way. To start an HR program follow the instructions below or just select the **HR 55%, HR 65%, HR 75% or HR 85%** program, then the Enter button and follow the directions in the **Message Center**.

After selecting your heart rate target, the program will attempt to keep you at or within 3 - 5 heart beats per minute of this value. Follow the prompts in the **Message Center** to maintain your selected heart rate value.

1. Press the **PROGRAM KEY** to select **HR PROGRAM** then press **ENTER**.
2. Press the **PROGRAM** key to select target HR 55%, target HR 65%, target HR 75% or target 85%, then press the **Enter** key.
3. The Message Center will ask you to enter your **Age**. You may enter your age, using the **Level + or -** keys, then press the **Enter** key to accept the new value and proceed on to the next screen.
4. You are now asked to enter your **Weight**. You may adjust the weight value using the **Level + or -** keys, then press **Enter** to continue.
5. Next is **Time**. You may adjust the time using the **Level + or -** keys and press **Enter** to continue.
6. Now you are asked to adjust the Heart Rate Target. This is the heart rate level you will strive to maintain during the program. Adjust the level using the **Level + or -** keys, then press **Enter**.
Note: The heart rate that appears is based on the % you accepted in Step 2. If you change this number it will either increase or decrease the % from Step 2.
7. Now you are finished editing the settings and can begin your workout by pressing the **Start** key. You can also go back and modify your settings by pressing the **Enter** key.
Note: At any time during the editing of Data you can press the **Stop** key to go back one screen.
8. If you want to increase or decrease the workload at any time during the program press the **Level + or -** key on the console. This will allow you to change your target heart rate at any time during the program.

HEART RATE EXERTION

Before we get started, a word about Heart Rate:

The old motto, “no pain, no gain”, is a myth that has been overpowered by the benefits of exercising comfortably. A great deal of this success has been promoted by the use of heart rate monitors. With the proper use of a heart rate monitor, many people find that their usual choice of exercise intensity was either too high or too low and exercise is much more enjoyable by maintaining their heart rate in the desired benefit range.

To determine the benefit range in which you wish to train, you must first determine your Maximum Heart Rate. This can be accomplished by using the following formula: 220 minus your age. This will give you the Maximum heart rate (MHR) for someone of your age. To determine the effective heart rate range for specific goals you simply calculate a percentage your MHR. Your Heart rate training zone is 50% to 90% of your maximum heart rate. 60% of your MHR is the zone that burns fat while 80% is for strengthening the cardio vascular system. This 60% to 80% is the zone to stay in for maximum benefit.

For someone who is 40 years old their target heart rate zone is calculated:

$220 - 40 = 180$ (maximum heart rate)
 $180 \times .6 = 108$ beats per minute (60% of maximum)
 $180 \times .8 = 144$ beats per minute (80% of maximum)

So for a 40 year old the training zone would be 108 to 144 beats per minute.

If you enter your age during programming the console will perform this calculation automatically. Entering your age is used for the Heart Rate control programs. After calculating your Maximum Heart Rate you can decide upon which goal you would like to pursue.

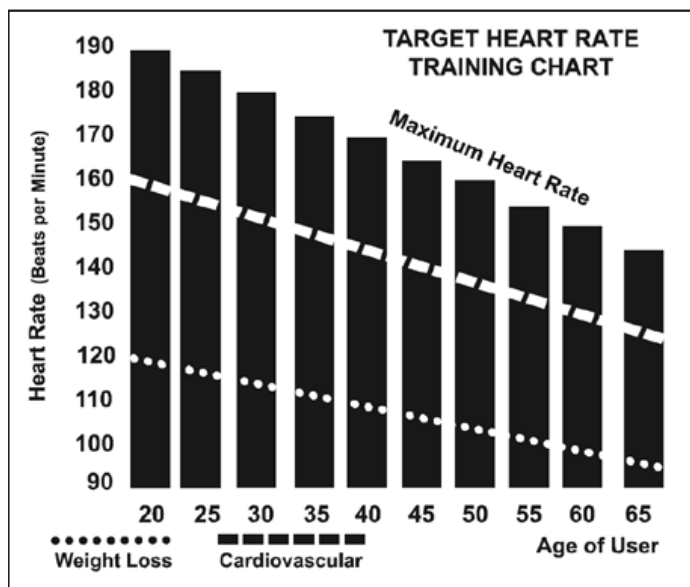

The two most popular reasons for, or goals, of exercise are cardiovascular fitness (training for the heart and lungs) and weight control. The black columns on the chart above represent the Maximum Heart Rate for a person whose age is listed at the bottom of each column. The training heart rate, for either cardiovascular fitness or weight loss, is represented by two different lines that cut diagonally through the chart. A definition of the lines' goal is in the bottom left-hand corner of the chart. If your goal is cardiovascular fitness or if it is weight loss, it can be achieved by training at 80% or 60%, respectively, of your Maximum Heart Rate on a schedule approved by your physician. Consult your physician before participating in any exercise program.

With all Heart Rate Control elliptical you may use the heart rate monitor feature without using the Heart Rate Control program. This function can be used during manual mode or during any of the nine different programs. The Heart Rate Control program automatically controls resistance at the pedals.

HEART RATE - PERCEIVED EXERTION

Heart rate is important but listening to your body also has a lot of advantages. There are more variables involved in how hard you should workout than just heart rate. Your stress level, physical health, emotional health, temperature, humidity, the time of day, the last time you ate and what you ate, all contribute to the intensity at which you should workout. If you listen to your body, it will tell you all of these things.

The rate of perceived exertion (RPE), also know as the Borg scale, was developed by Swedish physiologist G.A.V. Borg. This scale rates exercise intensity from 6 to 20 depending upon how you feel or the perception of your effort.

The scale is as follows:

Rating Perception of Effort

6 Minimal

7 Very, very light

8 Very, very light +

9 Very light

10 Very light +

11 Fairly light

12 Comfortable

13 Somewhat hard

14 Somewhat hard +

15 Hard

16 Hard +

17 Very hard

18 Very hard +

19 Very, very hard

20 Maximal

You can get an approximate heart rate level for each rating by simply adding a zero to each rating. For example a rating of 12 will result in an approximate heart rate of 120 beats per minute. Your RPE will vary depending up the factors discussed earlier. That is the major benefit of this type of training. If your body is strong and rested, you will feel strong and your pace will feel easier. When your body is in this condition, you are able to train harder and the RPE will support this. If you are feeling tired and sluggish, it is because your body needs a break. In this condition, your pace will feel harder. Again, this will show up in your RPE and you will train at the proper level for that day.

USING HEART RATE TRANSMITTER (OPTIONAL)

How to wear your wireless chest strap transmitter:

1. Attach the transmitter to the elastic strap using the locking parts.
2. Adjust the strap as tightly as possible as long as the strap is not too tight to remain comfortable.
3. Position the transmitter with the logo centered in the middle of your body facing away from your chest (some people must position the transmitter slightly left of center). Attach the final end of the elastic strap by inserting the round end and, using the locking parts, secure the transmitter and strap around your chest.
4. Position the transmitter immediately below the pectoral muscles.
5. Sweat is the best conductor to measure very minute heart beat electrical signals. However, plain water can also be used to pre-wet the electrodes (2 ribbed oval areas on the reverse side of the belt and both sides of the transmitter). It's also recommended that you wear the transmitter strap a few minutes before your work out. Some users, because of body chemistry, have a more difficult time in achieving a strong, steady signal at the beginning. After "warming up", this problem lessens. As noted, wearing clothing over the transmitter/strap doesn't affect performance.
6. Your workout must be within range - distance between transmitter/receiver – to achieve a strong steady signal. The length of range may vary somewhat but generally stay close enough to the console to maintain good, strong, reliable readings. Wearing the transmitter immediately against bare skin assures you of proper operation. If you wish, you may wear the transmitter over a shirt. To do so, moisten the areas of the shirt that the electrodes will rest upon.



Note: The transmitter is automatically activated when it detects activity from the user's heart. Additionally, it automatically deactivates when it does not receive any activity. Although the transmitter is water resistant, moisture can have the effect of creating false signals, so you should take precautions to completely dry the transmitter after use to prolong battery life (estimated transmitter battery life is 2500 hours). The replacement battery is Panasonic CR2032.

The icon  lights up and the heart rate is displayed when successfully connected to a Bluetooth® heart rate chest strap. The icon will be off when the Bluetooth® heart rate chest strap is disconnected.

Erratic Operation

Caution! Do not use this elliptical for Heart Rate Control unless a steady, solid Actual Heart Rate value is being displayed. High, wild, random numbers being displayed indicate a problem.

Areas to look for interference which may cause erratic heart rate:

1. Microwave ovens, TV's, small appliances, etc.
2. Fluorescent lights.
3. Some household security systems.
4. Perimeter fence for a pet.
5. Some people have problems with the transmitter picking up a signal from their skin. If you have problems try wearing the transmitter upside down. Normally the transmitter will be oriented so the logo is right side up.
6. The antenna that picks up your heart rate is very sensitive. If there is an outside noise source, turning the whole machine 90 degrees may de-tune the interference.
7. Another Individual wearing a transmitter within 3' of your machine's console.

If you continue to experience problems contact your dealer.

Maintenance & Care

1. Wipe down all areas in the sweat path with a damp cloth after each workout.
2. If a squeak, thump, clicking or rough feeling develops the main cause is most likely one of two reasons:
 - I. The hardware was not sufficiently tightened during assembly. All bolts that were installed during assembly need to be tightened as much as possible. It may be necessary to use a larger wrench than the one provided if you cannot tighten the bolts sufficiently. I cannot stress this point enough; 90% of calls to the service department for noise issues can be traced to loose hardware.
 - II. The crank arm nut needs to be retightened. If squeaks or other noises persist, check that the unit is properly leveled. There are 2 leveling pads on the bottom of the rear stabilizer, use a 14mm wrench (or adjustable wrench) to adjust the levelers.

Post-Workout Machine Care

1. Store your machine according to the folding instructions when not in use.
2. Use a slightly damp cloth to clean areas where sweat or oil made contact with the machine.
3. Use a microfiber cloth to clean the touchscreen and remove unwanted oils and other things that may damage the screen.
4. Avoid leaving paper or other small debris in the cupholders.

Sanitizing Your Fitness Equipment

- Upholstered high-contact surfaces (hard plastics) can be sanitized using a 75% isopropyl alcohol solution and a clean, dry cloth. Spray surfaces to be sanitized, and use the dry cloth to wipe clean. Allow surfaces to dry before using.
- For upholstered or soft-plastic surfaces, use a conditioner after sanitizing. Be sure to follow the instructions provided by the conditioner manufacturer to ensure proper use of the conditioner.
- Alternatively, you can make your own spray by mixing the proper ratio of isopropyl alcohol and distilled water to reach a 75% solution.

Engineering Mode Menu

The console has built in maintenance/diagnostic software. The software will allow you to change the console settings from English to Metric and turn off the beeping of the speaker when a key is pressed for example. To enter the Engineering Mode Menu, press and hold down the **Start, Stop and Enter** keys. Keep holding the keys down for about 5 seconds and the Message Center will display Engineering Mode Menu. Press the **Enter** key to access the menu below:

1. Key Test (Will allow you to test all the keys to make sure they are functioning)
2. Display Test (Tests all the display functions)
3. Functions (Press **Enter** to access settings and **+ or-** arrow to scroll)
 - I. ODO Reset (Resets the odometer)
 - II. Units (Sets the display to readout in English or Metric display measurements)
 - III. Sleep Mode (Turn off to have the console power down automatically after 15 minutes of inactivity)
 - IV. Pause Mode (Turn on allow 5 minutes of pause, turn off to have the console pause indefinitely)
 - V. Beep (Turns off the speaker so no beeping sound is heard)
 - VI. Motor test (Continually runs the tensioning gear motor)
4. Child Lock (Allows the keypad to be locked to prevent unauthorized use)
5. Exit

Exploded View Diagram

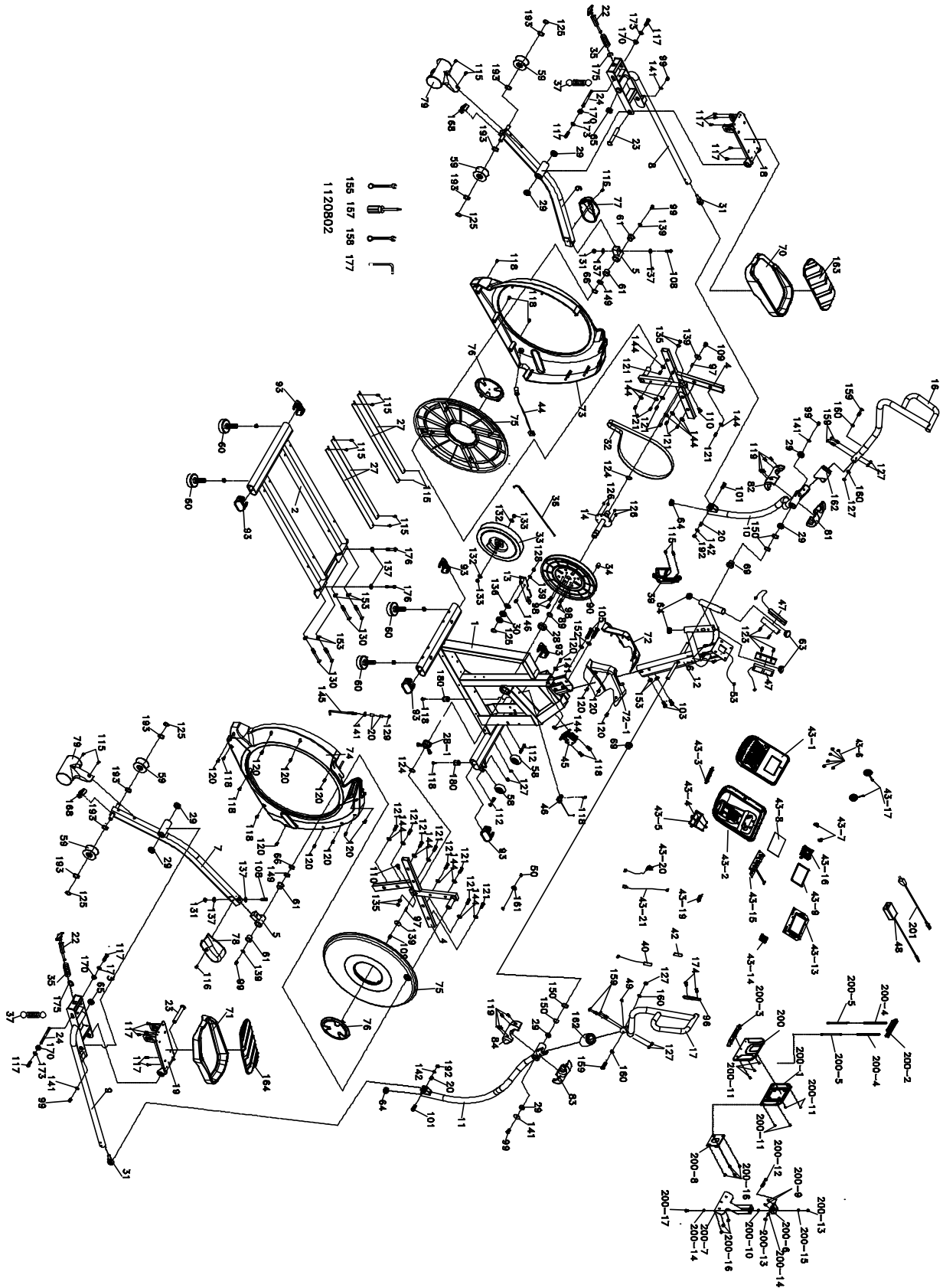

Parts List

KEY NO.	DESCRIPTION	Q'TY
1	Main Frame	1
2	Rear Rail Assembly	1
4	Cross Bar	2
5	Bushing Housing, Pedal Arm	2
6	Pedal Arm (L)	1
7	Pedal Arm (R)	1
8	Connecting Arm (L)	1
9	Connecting Arm (R)	1
10	Lower Handle Bar (L)	1
11	Lower Handle Bar (R)	1
12	Console Mast	1
13	Idler Bracket	1
14	Crank Axle	1
16	Swing Arm (L)	1
17	Swing Arm (R)	1
18	Adjustable Pedal (L)	1
19	Adjustable Pedal (R)	1
20	Rod End Sleeve	4
22	Locking Pin Assembly	2
23	Carriage Bolt	2
24	Axle Of Locking Pin	2
27	Aluminum Rail	4
28	6005_Bearing	1
28-01	6005_Bearing	1
29	6003_Bearing	8
30	6203_Bearing	2
31	M12 × P1.75_Rod End Bearing	2
32	Drive Belt(8J500)	1
33	Flywheel	1
34	Magnet	1
35	Latch Spring	2
36	Steel Cable	1
37	Pedal Tension Spring	2
39	Drink Bottle Holder	1
40	Resistance Button W/Cable	1
42	Handgrip Resistance Label (LEVEL+-)	1
43	Console Assembly	1
44	600m/m_DC Power Cord	1
45	Gear Motor	1

KEY NO.	DESCRIPTION	Q'TY
46	400m/m_Sensor W/Cable	1
47	850m/m_Handpulse W/Cable Assembly	2
48	Power Adaptor	1
49	450m/m_Handle Wire (Upper), Resistance	1
50	900m/m_Handle Wire, Resistance/Incline	1
53	1200m/m_Computer Cable	1
58	Transportation Wheel	2
59	Sliding Wheel Urethane	4
60	Rubber Foot	4
61	WFM-2528-21_Bushing	4
63	Ø32(1.8T)_Button Head Plug	2
64	Ø32 × 1.8T_Round Cap	4
65	32 × 2.5T_Round Cap	2
66	Ø25.5 × 33.5 × 1.5T_Nylon Wave Washer	2
69	Ø30 × 19m/m_Upright Bushing	2
70	Pedal (L)	1
71	Pedel (R)	1
72	Console Mast Cover(L)	1
72-01	Console Mast Cover(R)	1
73	Chain Cover (L)	1
74	Chain Cover (R)	1
75	Round Disk	2
76	Round Disk Cover	2
77	Pedal Arm Cover (L)	1
78	Pedal Arm Cover (R)	1
79	Slide Wheel Cover	2
81	Front Handle Bar Cover (L)	1
82	Rear Handle Bar Cover (L)	1
83	Front Handle Bar Cover (R)	1
84	Rear Handle Bar Cover (R)	1
89	Spacer Bushing	1
90	Drive Pulley	1
93	Handgrip End Cap	6
96	Handle Switch Bracket	1
97	Woodruff Key	2
98	1/4" × UNC20 × 3/4" _Hex Head Bolt	4
99	5/16" × UNC18 × 15L _Hex Head Bolt	6
101	5/16" × 1-1/4" _Hex Head Bolt	2
103	3/8" × 3/4" _Hex Head Bolt	2
105	3/8" × 2-1/4" _Hex Head Bolt	2

KEY NO.	DESCRIPTION	Q'TY
108	3/8" × 2-1/4" _Socket Head Cap Bolt	2
109	5/16" × UNC18 × 15L _Flat Head Socket Bolt	2
110	M8 × 1.25 × 40mm _Socket Head Cap Bolt	2
112	5/16" × 1-3/4" _Button Head Socket Bolt	2
115	M5 × 12mm _Phillips Head Screw	14
116	M5 × 10mm _Phillips Head Screw	6
117	M5 × 10mm _Phillips Head Screw	14
118	5 × 19mm _Tapping Screw	11
119	3.5 × 12mm _Sheet Metal Screw	8
120	3.5 × 16mm _Sheet Metal Screw	13
121	5 × 16mm _Tapping Screw	16
123	3 × 20mm _Tapping Screw	4
124	Ø25 _C Ring	2
125	Ø17 _C Ring	5
126	1/4" × 8T _Nylon Nut	4
127	5/16" × 7T _Nylon Nut	8
128	M8 × 7T _Nylon Nut	1
129	M8 × 9T _Nylon Nut	1
130	3/8" × 3-3/4" _Button Head Socket Bolt	4
131	3/8" × 11T _Nylon Nut	2
132	3/8" × UNF26 × 4T _Nut	2
133	3/8" × UNF26 × 11T _Nut	2
135	M8 × 6.3T _Nut	4
136	Ø17 × Ø23.5 × 1.0T _Flat Washer	1
137	Ø3/8" × Ø19 × 1.5T _Flat Washer	6
139	Ø5/16" × Ø35 × 1.5T _Flat Washer	5
141	Ø5/16" × Ø23 × 1.5T _Flat Washer	6
142	Ø5/16" × Ø20 × 1.5T _Flat Washer	2
144	Ø1/4" × 19mm _Flat Washer	17
145	M8 × 170mm _J Bolt	1
146	M8 × 20mm _Carriage Bolt	1
149	Ø25 _Wave Washer	2
150	Ø17 × 0.3T _Wave Washer	4
152	Ø10 × 2T _Split Washer	2
153	Ø3/8" × 23 × 2.0T _Curved Washer	6
155	13/14m/m _Wrench	1
157	Phillips Head Screw Driver	1
158	12/14m/m _Wrench	1
159	5/16" × 1-3/4" _Hex Head Bolt	6
160	Ø8 × 23 × 1.5T _Curved Washer	4

KEY NO.	DESCRIPTION	Q'TY
161	Switch Wire Cap	1
162	Swing Arm Bushing	2
163	Pedal Foam (L)	1
164	Pedal Foam (R)	1
168	Oval End Cap	2
170	Ø19 × Ø14 × Ø10 × (5+4)_Bushing	4
173	Ø5 × Ø15 × 1.5T_Flat Washer	4
174	M5 × 15mm_Flat Head Socket Screw	2
175	Ø10_C Ring	2
176	3/8" × 2-1/4" _Button Head Socket Bolt	2
177	L Allen Wrench	1
192	5/16" × 9T_Nylon Nut	2
193	Ø17 × 0.5T_Wave Washer	8
180	Rubber Foot Pad	2
200	IPAD Front Cover	1
200-1	IPAD Rear Cover	1
200-2	IPAD Cover (Top clip)	1
200-3	IPAD Cover (Bottom clip)	1
200-4	Spring	2
200-5	spring column	2
200-6	Rotate Axle Bracket	1
200-7	IPAD Tablet Holder Assembly	1
200-8	Console Holder Assembly	1
200-9	Flat Washer(8.2×16×0.6T)	2
200-10	Pad	1
200-11	3.5 × 12mm_Sheet Metal Screw	7
200-12	5/16" × 2-1/2" _Hex Head Bolt	1
200-13	5/16" × 6T_Nylon Nut	2
200-14	Ø5/16" × 16 × 1.5T_Flat Washer	2
200-15	Ø8 × 1.5T_Split Washer	1
200-16	M5 × 12mm_Phillips Head Screw	7
200-17	5/16" × 15mm_Hex Head Bolt	1
201	Transformer Power Cord	1

MANUFACTURER'S LIMITED WARRANTY

Dyaco Canada Inc. warrants all its elliptical parts for a period of time listed below, from the date of retail sale, as determined by a sales receipt. Dyaco Canada Inc.'s responsibilities include providing new or remanufactured parts at Dyaco Canada Inc.'s option and technical support to our independent dealers and servicing organizations. In the absence of a dealer or service organization, these warranties will be administered by Dyaco Canada Inc. directly to a consumer. The warranty period applies to the following components:

Limited Warranty

Frame and Brake: Lifetime

Parts: 5 Years

Labour: 1 Year

This warranty is not transferable and is extended only to the original owner.

The warranty shall not apply to exercise units that are (1) used for commercial or other income-producing purposes or (2) subject to misuse, neglect, accident or unauthorized repair and alterations.

This warranty provided herein is in lieu of all other express warranties; any implied warranties, including any implied warranties of merchantability or fitness for a particular purpose, are limited in duration to the first 12 months from the date of purchase. All other obligations or liabilities, including liability for consequential damages, are hereby excluded.

REPAIR PARTS AND SERVICE

All of the parts for the Spirit cycle shown in this manual can be ordered from Dyaco Canada Inc. 5955 Don Murie Street, Niagara Falls, Ontario L2G 0A9. When ordering parts, the parts will be sent and billed at the current prices. Prices may be subject to change without notice.

A Credit Card, Cheque, or Money Order must accompany all orders. Standard hardware items are available at your local hardware store.

To ensure prompt and correct handling of any errors, or to answer any questions, please call our Toll Free number: 1-888-707-1880, or local number 1-905-353-8955 or fax 1-905-353-8968, email customerservice@dyaco.ca or visit our website at www.dyaco.ca. Office hours are from 8:30 AM to 5:00 PM Monday to Friday Eastern Standard Time.

Always include the following information when ordering parts

- Model number
- Name of each part
- Part number of each part

dyaco

Please visit us online for information about our other brands and products manufactured and distributed by Dyaco Canada Inc.

SPIRIT

spiritfitness.ca

SOLE
FITNESS

solefitness.ca

X XTERRA

xterrafitness.ca

EVERLAST

dyaco.ca/products/everlast.html

UFC

dyaco.ca/UFC/UFC-home.html

Johnny G
by **SPIRIT**

spiritfitness.ca/johnnyg.html

TRAINOR
SPORTS

trainorsports.ca

For more information, please contact Dyaco Canada Inc.

T: 1-888-707-1880 | 5955 Don Murie St., Niagara Falls, Ontario L2G 0A9 | sales@dyaco.ca

Dyaco Canada Inc. dyaco.ca