

Owner's Manual

Model No.
16207789000
CR900

- Assembly
- Operation
- Adjustments
- Parts
- Warranty

CAUTION:
Read and
understand this
manual before
operating unit

SPIRIT



Retain For Future Reference

TABLE OF CONTENTS

Product Registration	3
Important Safety Instructions	6
Important Electrical Informations	7
Important Operation Instructions.....	7
Assembly Instructions.....	9
Operation of Your Bike	15
Program Features.....	18
Using Heart Rate Transmitter (optional)	25
General Maintenance	28
Exploded View Diagram	29
Parts List.....	30
Training Guidelines.....	34
Stretching	38
Manufacturer's Limited Warranty.....	40

Thank you for purchasing our product, please save these instructions. Please do not perform or attempt any customizing, adjustments, repair or maintenance that is not described in this manual.

SPIRIT

**CONGRATULATIONS ON YOUR
NEW BIKE AND WELCOME
TO THE SPIRIT FAMILY!**

Thank you for your purchase of this quality stationary bike trainer from Dyaco Canada Inc. Your new bike was manufactured by one of the leading fitness manufacturers in the world and is backed by one of the most comprehensive warranties available. Through your dealer, Dyaco Canada Inc. will do all we can to make your ownership experience as pleasant as possible for many years to come. The local dealership where you purchased this bike is your administrator for all Dyaco Canada Inc. warranty and service needs. Their responsibility is to provide you with the technical knowledge and service personnel to make your experience more informed and any difficulties easier to remedy.

Please take a moment at this time to record the name of the dealer, their telephone number, and the date of purchase below to make any future, needed contact easy. We appreciate your support and we will always remember that you are the reason that we are in business. Please complete and mail your registration card today and enjoy your new bike.

Yours in Health,
Dyaco Canada Inc.

Name of Dealer _____

Telephone Number of Dealer _____

Purchase Date _____

Product Registration

RECORD YOUR SERIAL NUMBER

Please record the Serial Number of this fitness product in the space provided below.

Serial Number _____

REGISTER YOUR PURCHASE

The self-addressed product registration card must be completed in full and returned to Dyaco Canada Inc.

BEFORE YOU BEGIN

Thank you for choosing the SPIRIT CR900 Bike. We take great pride in producing this quality product and hope it will provide many hours of quality exercise to make you feel better, look better, and enjoy life to its fullest. It's a proven fact that a regular exercise program can improve your physical and mental health. Too often, our busy lifestyles limit our time and opportunity to exercise. The SPIRIT CR900 Bike provides a convenient and simple method to begin your assault on getting your body in shape and achieving a happier and healthier lifestyle. Before reading further, please review the drawing below and familiarize yourself with the parts that are labeled.

Read this manual carefully before using the SPIRIT CR900 Bike. Although Dyaco Canada Inc. constructs its products with the finest materials and uses the highest standards of manufacturing and quality control, there can sometimes be missing parts or incorrectly sized parts. If you have any questions or problems with the parts included with your SPIRIT CR900 Bike, please do not return the product. Contact us **FIRST!** If a part is missing or defective call us toll free at 1-888-707-1880. Our Customer Service Staff are available to assist you from 8:30 A.M. to 5:00 P.M. (Eastern Time) Monday through Friday. Be sure to have the name and model number of the product available when you contact us.

SAFETY PRECAUTIONS

IMPORTANT SAFETY INFORMATION READ ALL INSTRUCTIONS BEFORE USING THIS BIKE

CAUTION: Before starting any exercise program, it is recommended that you consult your physician.

Thank you for purchasing our product. Even though we go to great efforts to ensure the quality of each product we produce, occasional errors and/or omissions do occur. In any event should you find this product to have either a defective or a missing part please contact us for a replacement.

This exercise equipment was designed and built for optimum safety. However, certain precautions apply whenever you operate a piece of exercise equipment. Be sure to read the entire manual before assembly and operation of this machine. Also, please note the following safety precautions:

1. Read the OWNER'S OPERATING MANUAL and all accompanying literature and follow it carefully before using your bike.
2. It is the responsibility of the facility to ensure that all users of the bike exerciser are adequately informed of all precautions.
3. If dizziness, nausea, chest pains, or any other abnormal symptoms are experienced while using this equipment, STOP the workout at once. CONSULT A PHYSICIAN IMMEDIATELY.
4. Inspect your exercise equipment prior to exercising to ensure that all nuts and bolts are fully tightened before each use.
5. The bike must be regularly checked for signs of wear and damage. Any part found defective, the part must be replaced with new spare part from the manufacturer.
6. Fitness equipment must always be installed on a flat surface, do not place the unit on a loose rug or uneven surface. It is recommended to use an equipment mat to prevent the unit from moving while it is being used, which could possibly scratch or damage the surface of your floor. Keep the bike exerciser indoors, away from moisture and dust.
7. No changes must be made which might compromise the safety of the equipment.
8. It is recommended to have a minimum of 1' safe clearance around the exercise equipment while in use.
9. Keep children and pets away from this equipment at all times while exercising.
10. Warm up 5 to 10 minutes before each workout and cool down 5 to 10 minutes afterward. This allows your heart rate to gradually increase and decrease and will help prevent you from straining muscles.
11. Never hold your breath while exercising. Breathing should remain at a normal rate in conjunction with the level of exercise being performed.
12. Always wear suitable clothing and footwear while exercising. Do not wear loose fitting clothing that could become entangled with the moving parts of your bike.
13. Always hold the handlebars when mounting, dismounting, or using the bike exerciser.
14. Keep your back straight when using the bike exerciser; do not arch your back.
15. If decals on the bike exerciser are missing or illegible, please call our customer service department toll free at 1-888-707-1880 and order a replacement decal.
16. Care must be taken when lifting or moving the equipment, so as not to injure your back. Always use proper lifting techniques
17. User weight should not exceed 450 lbs (204 kgs)

WARNING: Before beginning any exercise program consult your physician. This is especially important for individuals over the age of 35 or persons with pre-existing health problems. Read all instructions before using any fitness equipment. We assume no responsibility from personal injury or property damage sustained by or through the use of this product.

SAVE THESE INSTRUCTIONS

IMPORTANT SAFETY INSTRUCTIONS

WARNING - Read all instructions before using this equipment.

WARNING - Heart rate monitoring systems may be inaccurate. Over exercising may result in serious injury or death. If you feel faint stop exercising immediately.

- Do not operate bike on deeply padded, plush or shag carpet. Damage to both carpet and bike may result.
- Keep children under the age of 13 away from the bike. There are obvious pinch points and other caution areas that can cause harm.
- Keep hands away from all moving parts.
- Do not operate where aerosol spray products are being used or where oxygen is being administered. Sparks from the motor may ignite a highly gaseous environment.
- Never drop or insert any object into any openings.
- Do not use outdoors.
- Do not attempt to use your bike for any purpose other than for the purpose it is intended.
- The hand pulse sensors are not medical devices. Various factors, including the user's movement, may affect the accuracy of heart rate readings. The pulse sensors are intended only as exercise aids in determining heart rate trends in general.
- Wear proper shoes. High heels, dress shoes, sandals or bare feet are not suitable for use on your bike. Quality athletic shoes are recommended to avoid leg fatigue.
- This equipment is not intended for use by persons with reduced physical, sensory or mental capabilities, or lack of experience and knowledge, unless they have been given supervision or instruction concerning use of the equipment by a person responsible for their safety.

SAVE THESE INSTRUCTIONS - THINK SAFETY!

IMPORTANT ELECTRICAL INFORMATIONS

WARNING!

Be aware that the generator is producing AC power while the bike is being used. Do not service the bike while the generator is spinning; serious electric shock could occur.

NEVER expose this bike to rain or moisture. This product is **NOT** designed for use outdoors, near a pool or spa, or in any other high humidity environment. The operating temperature specification is 40 to 120 degrees Fahrenheit, and humidity is 95% non-condensing (no water drops forming on surfaces).

IMPORTANT OPERATION INSTRUCTIONS

- **NEVER** operate this bike without reading and completely understanding the results of any operational change you request from the computer.
- Understand that changes in resistance do not occur immediately. Set your desired resistance on the computer console and release the adjustment key. The computer will obey the command gradually.
- Use caution while participating in other activities while pedaling on your bike; such as watching television, reading, etc. These distractions may result in serious injury.
- Always hold on to a handrail or hand bar while making control changes (resistance, etc.).
- Do not use excessive pressure on console control keys. They are precision set to function properly with little finger pressure. Pushing harder is not going to make the unit go faster or slower. If you feel the buttons are not functioning properly with normal pressure contact your dealer.

WARNING DECAL REPLACEMENT

The decal shown below has been placed on the bike. If the decal is missing or illegible, please call our Customer Service Department toll-free at 1-888-707-1880 to order a replacement decal.

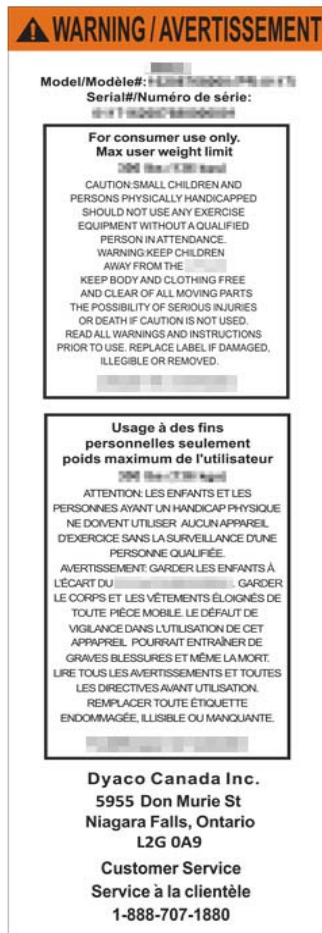

ASSEMBLY INSTRUCTIONS

PRE-ASSEMBLY

1. Cut the straps then along the dotted line on the bottom of the box; lift the box over the unit and unpack.
2. Carefully remove all parts from carton and inspect for any damage or missing parts. If damaged parts are found, or parts are missing, contact your dealer immediately.
3. Locate the hardware package. Remove the tools first. Remove the hardware for each step as needed to avoid confusion. The numbers in the instructions that are in parenthesis (#) correspond to the item number from the assembly drawing for reference.

ASSEMBLY TOOLS

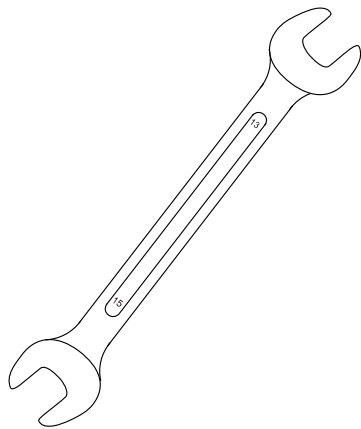

#126. 13/15mm
Wrench (1 pc)

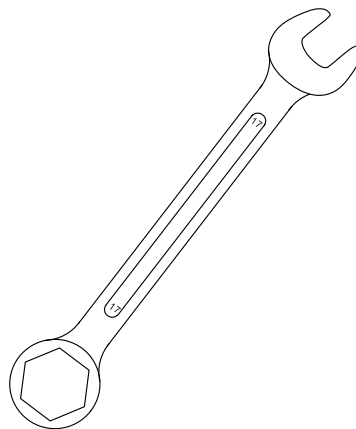

#125. 17 mm
Wrench (2 pc)

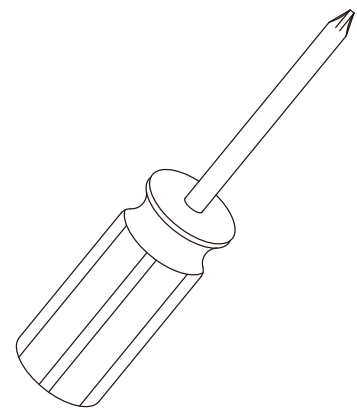

#122. Phillips Head
Screwdriver (1 pc)

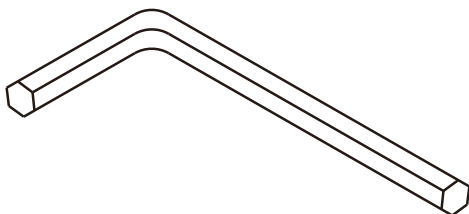

#124. 6mm L Allen Wrench (1 pc)

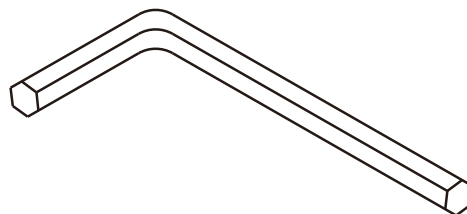

#123. 5mm L Allen Wrench (1 pc)

STEP 1

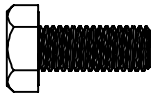

#145 - M10 x30mm
Hex Head Bolt (2pcs)



#92 - M6 x 12 mm Socket
Head Cap Bolt (6pcs)



#97 - M5 x12 mm
Phillips Head Screw
(2pcs)

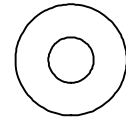

#106 - Ø3/8" x Ø25 x
2.0T Flat Washer (4pcs)



#108 - Ø1/4" x 13 x 1.0T
Flat Washer (6pcs)



#111 - Ø1/4"
Split Washer (6pcs)



#117 - 3.5 x12mm
Sheet Metal Screw
(5pcs)



#138 - Ø10 x 1.5T
Split Washer (4pcs)

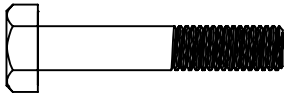

#139 - M10 x 55mm
Hex Head Bolt (2pcs)

STEP 2



#94 - M8 x 25mm
Socket Head Cap Bolt
(2pcs)



#97 - M5 x12mm
Phillips Head Screw
(8pcs)



#105 - Ø5/16" x Ø18 x
1.5T Flat Washer (2pcs)



#112 - Ø5/16" x 1.5T
Split Washer (2pcs)

STEP 3

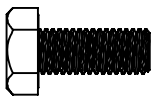

#85 - M10 x25mm
Hex Head Bolt
(6pcs)

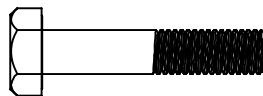

#86 - M10 x50mm
Hex Head Bolt
(6pcs)



#92 - M6 x 12 mm
Socket Head Cap Bolt
(2pcs)



#101 - M10 x 8T
Nyloc Nut (4pcs)

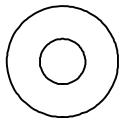

#106 - Ø3/8" x Ø25 x
2.0T Flat Washer (16pcs)



#108 - Ø1/4" x 13 x 1.0T
Flat Washer (2pcs)



#111 - Ø1/4"
Split Washer (2pcs)



#116 - 4 x12mm
Sheet Metal Screw
(6pcs)

STEP 4



#90 - M8 x 20mm Button
Head Socket Bolt (4pcs)

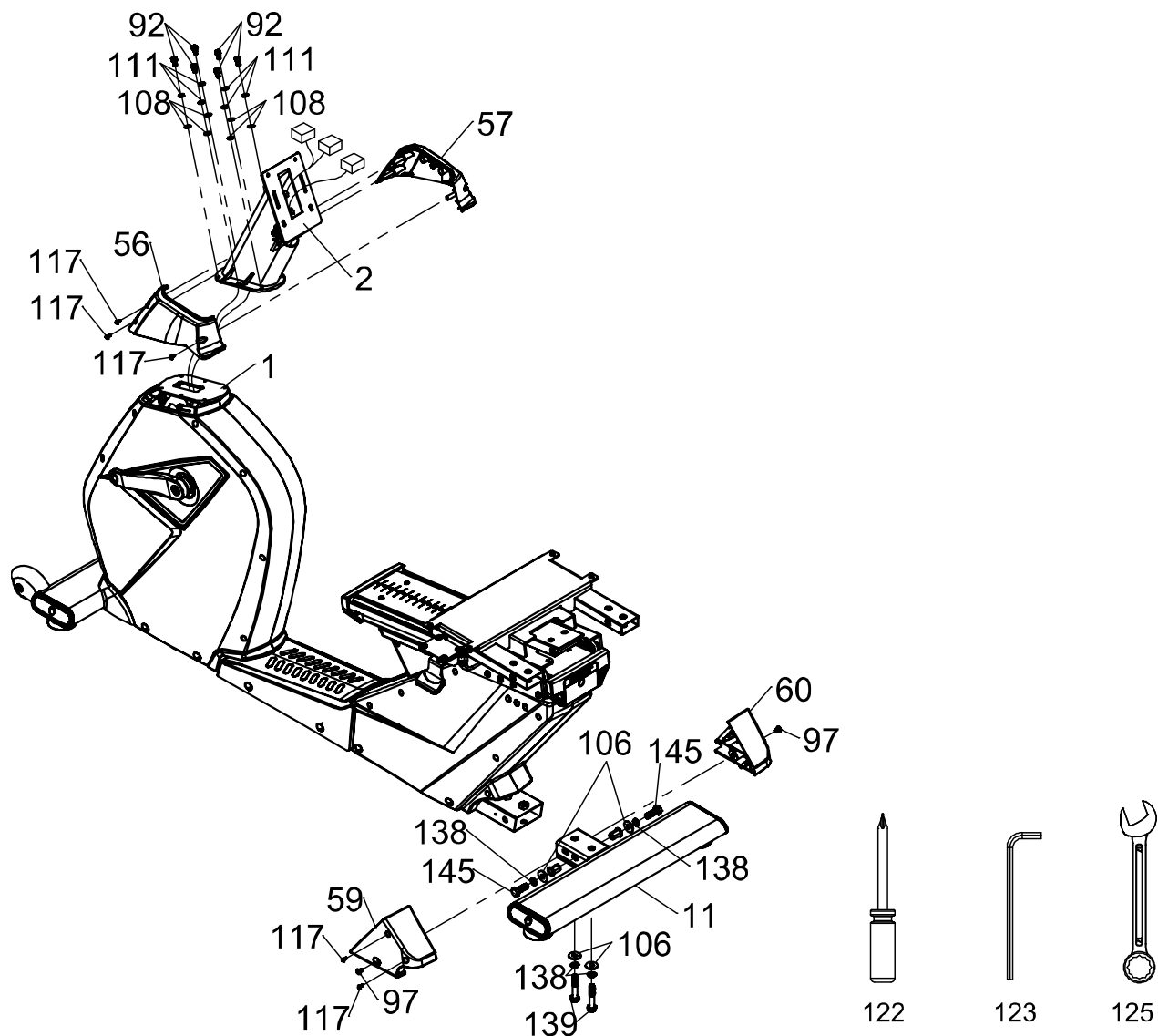

STEP 1

1. Install REAR STABILIZER (11) onto MAIN FRAME (1) with 2 short BOLTS (145), 2 long BOLTS (139), 4 SPLIT WASHERS (138), and 4 WASHERS (106).
2. Attach left and right STABILIZER COVERS (59 & 60) to MAIN FRAME (1) with 2 SCREWS (97). Join together with 2 SELF TAPPING SCREWS (117).
3. Run the WIRING HARNESS through the CONSOLE MAST (2) and out the top.
4. Attach CONSOLE MAST (2) to MAIN FRAME (1) using 6 BOLTS (92), 6 SPLIT WASHERS (111), and 6 WASHERS (108).
5. Place left and right CONSOLE MAST COVERS (56 & 57) around base of CONSOLE MAST (2). Join covers together with 3 SELF TAPPING SCREWS (117).

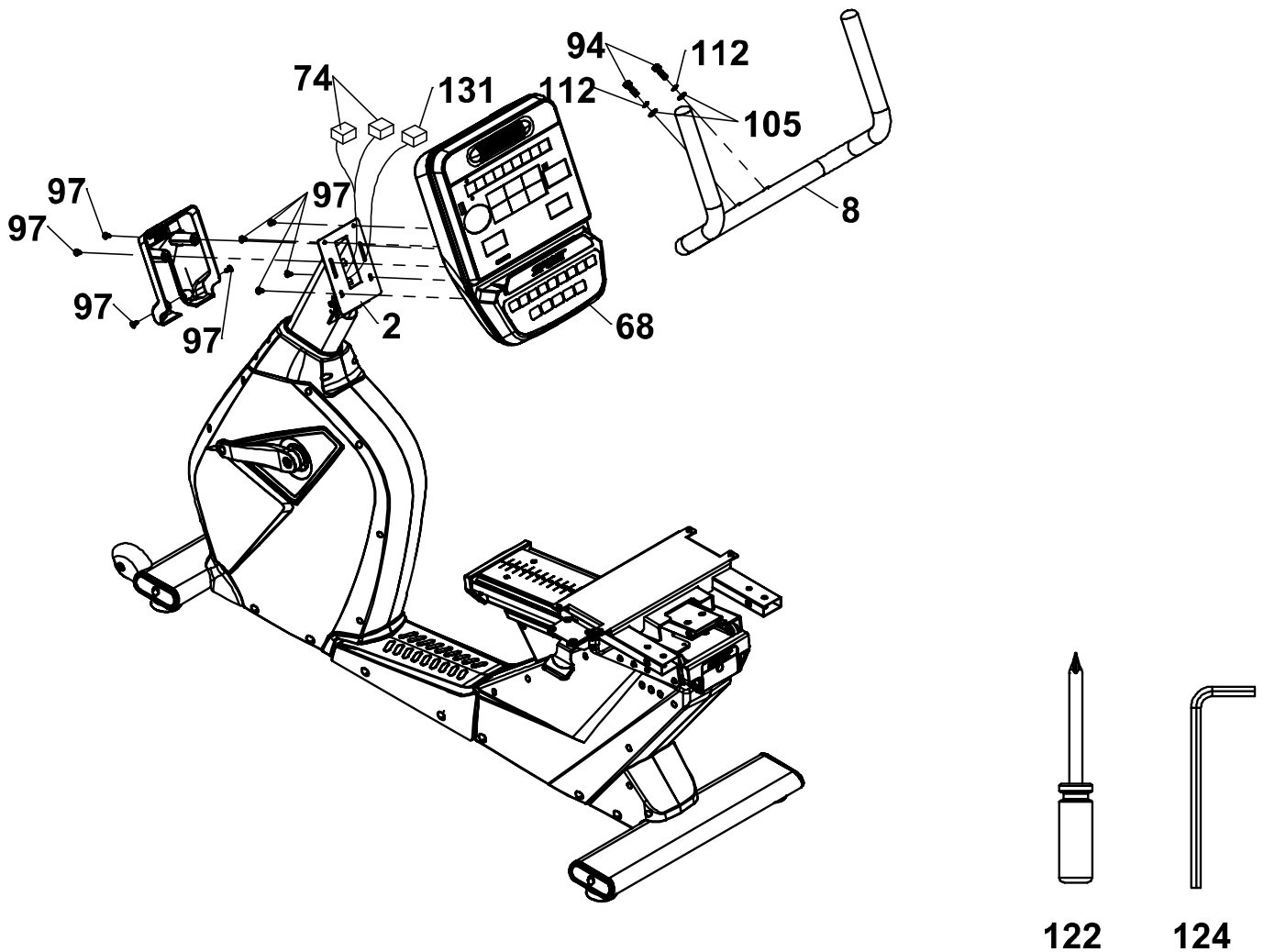

STEP 2

1. Attach FRONT HANDLEBAR (8) to CONSOLE MAST (2) with 2 BOLTS (94), 2 SPLIT WASHERS (112) and 2 WASHERS (105).
2. Connect WIRING HARNESS CABLES (74, 131) to CONSOLE (68).
3. Attach CONSOLE (68) to CONSOLE MAST (2) with 4 SCREWS (97). Ensure all cables do not become pinched.
4. Attach CONSOLE BRACKET COVER (64) to CONSOLE MAST (2) using 4 SCREWS (97).

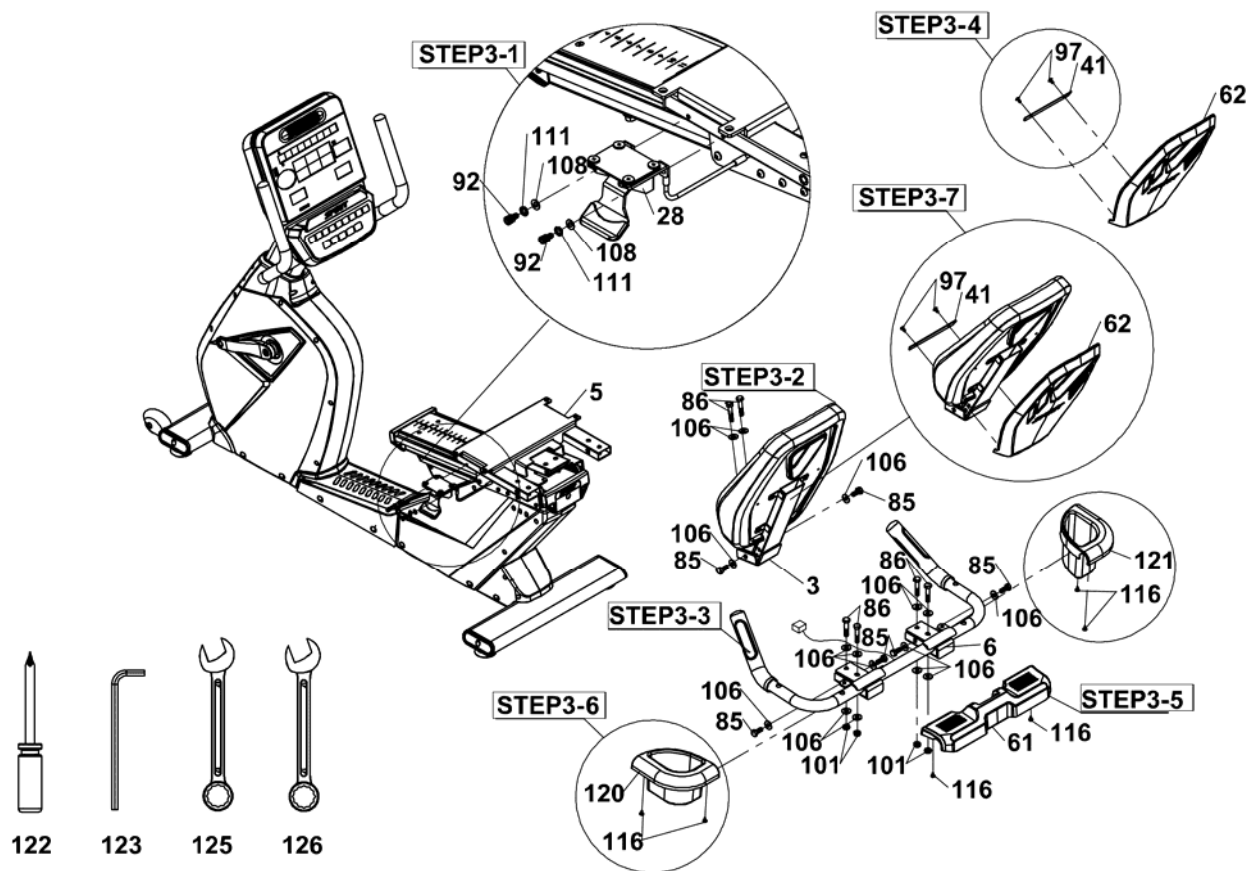

STEP 3

1. Install SEAT RELEASE LEVER (28) onto SEAT CARRIAGE FRAME (5) with 2 BOLTS (92), 2 LOCK WASHERS (111), and 2 WASHERS (108).
2. Install SEAT BACK FRAME (3) onto SEAT CARRIAGE FRAME (5) with 2 short BOLTS (85), 2 long BOLTS (86), and 4 WASHERS (106).
3. Attach REAR HANDLEBAR (6) to SEAT CARRIAGE FRAME (5) using 4 long BOLTS (86), 4 shot BOLTS (85), 12 WASHERS (106), and 4 NUTS (101). And connect the WIRING HARNESS CABLES between REAR HANDLEBAR (6) and SEAT CARRIAGE FRAME (5).
4. Loosen 2 SCREWS (97) to remove SEAT COVER RETAINING BRACKET (41) from SEAT BACK COVER (3).
5. Attach REAR HANDLEBAR COVER (61) to REAR HANDLEBAR (6) using 2 SELF TAPPING SCREWS (116).
6. Attach CUP HOLDERS (120 & 121) to REAR HANDLE BAR (6) using 4 SELF TAPPING SCREWS (116).
7. Attach SEAT BACK COVER (62) to SEAT BACK FRAME (3). Install SEAT COVER RETAINING BRACKET (41) using 2 SCREWS (97).

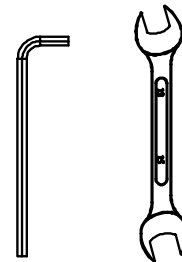
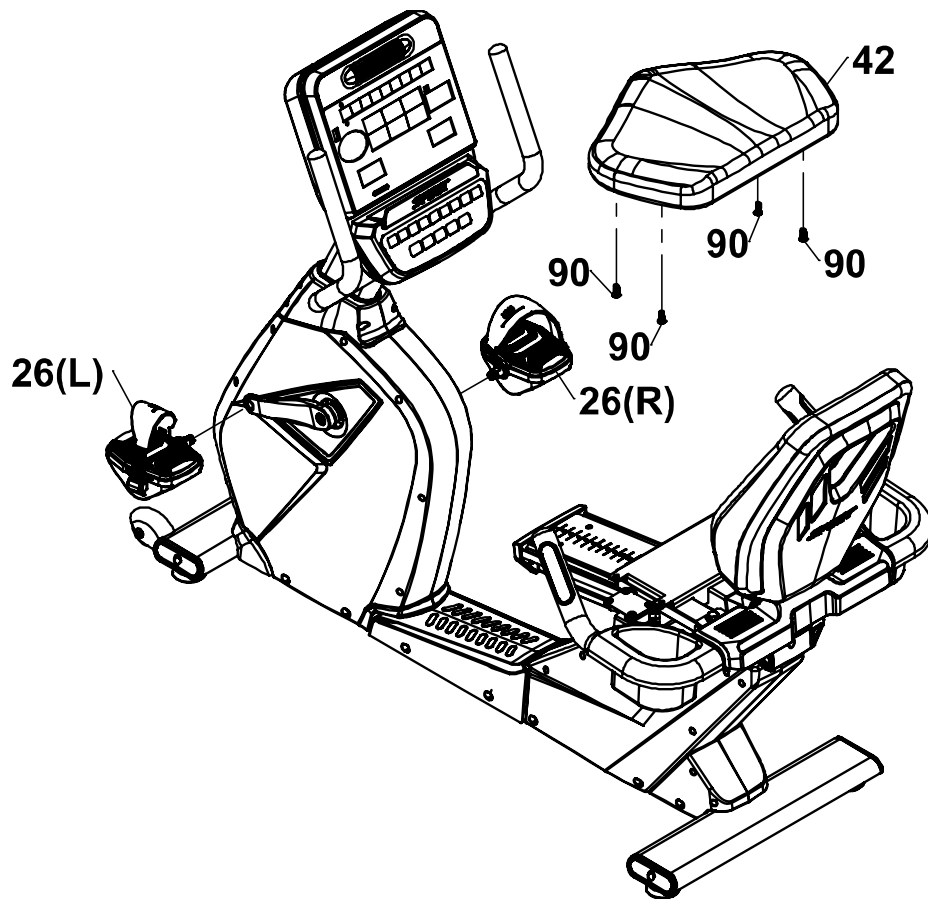

123

126

STEP 4

1. Install the PEDALS (26L & 26R) onto the CRANK ARMS (22 & 23). The left pedal has a reverse thread and will be screwed in counterclockwise.
2. Attach SEAT (42) to SEAT CARRIAGE FRAME (5) with 4 BOLTS (90).

OPERATION OF YOUR BIKE



POWER UP

Spirit Fitness commercial fitness bikes have a built-in generator for power and do not need to be plugged into an AC outlet. To power up the fitness bike simply start to pedal, the console will turn on automatically.

When initially powered on, the console will perform an internal self-test. During this time the display may not light up for a few seconds. Continue pedaling and the display will light up. Once powered on, the Message Window will be scrolling the start-up message. You may now begin your workout program. You can select a program or press start to begin.

C-SAFE FEATURE

Your console is equipped with a C-SAFE feature. The Power (POWER) port can be used for powering a remote controlled audio-visual system by connecting a cable from the remote to the Power port at the back of the console.

CONSOLE OPERATION

QUICK START

This is the quickest way to start a workout. After the console powers up you just press the Start key to begin. This will initiate the Quick Start mode. In Quick Start the Time will count up from zero, all workout data will start to accrue and the workload may be adjusted manually by pressing the Up and Down buttons. The dot matrix display will show just the bottom row lit. As you increase the workload more rows will light indicating a harder workout. The fitness bike will get harder to pedal as the rows increase. The dot matrix has 24 columns of lights and each column represents 1 minute. At the end of the 24th column (or 24 minutes of work) the display will wrap around and start at the first column again.

There are 40 levels of resistance – displayed as 10 rows of lights – available for plenty of variety. The first 10 levels are very easy workloads, and the changes between levels are set to a good progression for de-conditioned users. Levels 10-20 are more challenging but the increases from one level to the next remain small. Levels 20-30 start getting tough as the levels jump more dramatically. Levels 30-40 are extremely hard and are good for short interval peaks and elite athletic training.

BASIC INFORMATION

The Dot Matrix, or Profile Window, will display the workout Profile. The Message Window displays pertinent exercise data. There is an RPM Window for pedal speed and a Level window indicating machine resistance. A Heart Rate data window and bar graph show how hard you are working and a lap counter provides distance information. The Message Window will initially be displaying Watts, Time Elapsed, Calories and Distance information. On the left of the Message Window is a button labeled Scan. When the Scan button is pressed the next set of information will appear: METs, Time Remaining, Calories/Hour and Speed.

Pressing the Scan button, the Scan mode is activated and the Message Window will show each set of data for four seconds then switch to the next set of data in a continuous loop. Pressing the Scan button again will bring you back to the beginning.

To the right of the Profile Window is a Heart Icon, Heart Rate number display and a Bar Graph. The fitness bike has a built in heart rate monitoring system. Simply grasping the hand pulse sensors, or wearing a heart rate chest belt transmitter, will start the Heart Icon blinking (this may take a few seconds). The Heart Rate window will display your heart rate, or Pulse, in beats per minute. The Bar Graph represents the percentage of your maximum heart rate you are currently achieving.

NOTE: You must enter your age during program setup for the Bar Graph to be accurate.

The Stop key actually has several functions. Pressing the Stop key once during a program will Pause the program for 5 minutes (when you stop pedaling without AC power the display will turn off but the memory will be saved for 5 minutes just like the pause mode). If you need to get a drink, answer the phone, or any of the many things that could interrupt your workout, this is a great feature. To resume your workout during Pause just press the Start key or start pedaling. If the Stop key is pressed twice during a workout, the program will end and the console will return to the start-up screen. If the Stop key is held down for 3 seconds, the console will perform a complete Reset. During data entry for a program the Stop key performs a Previous Screen function. This allows you to go back one step in the programming each time you press the Stop key.

The Program Keys are used to preview each program. When you first turn the console on, you

may press each program key to preview what the program profile looks like. If you decide that you want to try a program, press the corresponding program key and then press the Enter key to select the program and enter into the data set-up mode.

Fans:

The console includes a built-in fan to help keep you cool. To turn the fan on, press the key on the upper right side of the console. This is a 3-speed fan and each time you press the key the airflow will increase accordingly. After the third setting the fan will turn off when the key is pressed again.



NUMBER KEY PAD

When you are in the data set-up mode setting new data such as age, weight etc., you can use these keys to enter the numbers quickly.

PROGRAMMING THE CONSOLE

Each of the programs can be customized with your personal information and changed to suit your needs. Some of the information asked for is necessary to ensure the readouts are correct. You will be asked for your Age and Weight. Entering your Age ensures that the Heart Rate bar graph shows the correct number. Your Age is also necessary during the Heart Rate control program to ensure the correct settings are in the program for your Age. Otherwise the work settings could be too high or low for you; entering your Weight aides in calculating a more correct Calorie reading. Although we cannot provide an exact calorie count we do want to be as close as possible.

CALORIE NOTE: Calorie readings on every piece of exercise equipment are not accurate and tend to vary widely. They are meant only as a guide to monitor your progress from workout to workout. The only way to measure your calorie burn accurately is in a clinical setting connected to a fit test monitoring equipment. This is because every person is different and burns calories at a different rate. Some good news is that you will continue to burn calories at an accelerated rate for at least an hour after you have finished exercising!

ENTERING A PROGRAM & CHANGING SETTINGS

When you enter a program (by pressing a program key then Enter key) you have the option of entering your own personal settings. If you want to work out without entering new settings, then just press the Start key. This will bypass the programming of data and take you directly to the start of your workout. If you want to change the personal settings, then just follow the instructions in the Message Window. If you start a program without changing the settings, the default, or pre-saved settings will be used.

Note: *Age and Weight default settings will change when you enter a new number. So the last **Age** and **Weight** entered will be saved as the new default settings. If you enter **Age** and **Weight** the first time you use the elliptical you will not have to enter it every time you work out unless either **Age** or **Weight** has changed or someone else enters a different **Age** and **Weight**.*

PROGRAMMABLE FEATURES

MANUAL PROGRAM

The Manual program works as the name implies, manually. This means that you control the workload yourself and not the computer. To start the Manual program, follow the instructions below or just press the Manual button then the Enter button and follow the directions in the Message Window.

1. Press the Manual key then press the Enter key.
2. The Message Window will ask you to enter your workout time. Adjust the time and press enter.
3. The Message Window will ask you to enter your Age. You may enter your Age, using the Up and Down keys or the numeric key pad, then press the Enter key to accept the new number and proceed on to the next screen.
4. You are now asked to enter your Weight. You may adjust the Weight number using the Up and Down keys, or the numeric key pad, then press enter to continue.
5. Now you are finished editing the settings and can begin your workout by pressing the Start key. You can also go back and modify your settings by pressing the Enter key. *NOTE: At any time during the editing of data you can press the Stop key to go back one level, or screen.*
6. The program automatically starts you at level one. This is the easiest level and it is a good idea to stay at level one for a while to warm up. If you want to increase the work load at any time press the Up key; the Down key will decrease the workload.
7. When the program ends you may press Start to begin the same program again or Stop to exit the program.

PRESET PROGRAMS

The fitness bike has four different programs that have been designed for a variety of workouts. These four programs have factory preset work level profiles for achieving different goals.

HILL

This program follows a triangle or pyramid type of gradual progression from approximately 10% of maximum effort (the level that you chose before starting this program) up to a maximum effort which lasts for 10% of the total workout time, then a gradual regression of resistance back to approximately 10% of maximum effort.

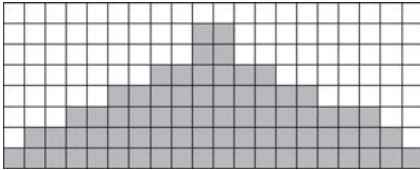

FATBURN

This program follows a quick progression up to the maximum resistance level (default or user input level) that is sustained for 2/3 of the workout. This program will challenge your ability to sustain your energy output for an extended period of time.

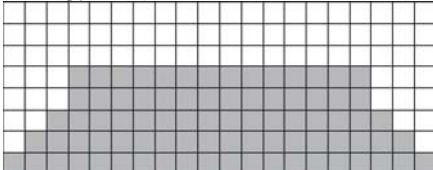

CARDIO

This program presents a quick progression up to near maximum resistance level (default or user input level). It has slight fluctuations up and down to allow your heart rate to elevate, and then recover repeatedly, before beginning a quick cool down. This will build up your heart muscle and increase blood flow and lung capacity.

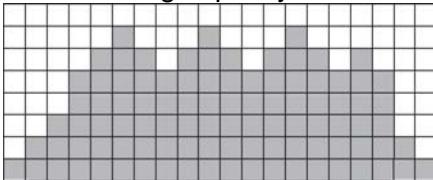

INTERVAL

This program takes you through high levels of intensity followed by recovery periods of low intensity. This program utilizes and develops your “Fast Twitch” muscle fibers which are used when performing tasks that are intense and short in duration. These deplete your oxygen level and spike your heart rate, followed by periods of recovery and heart rate drop to replenish oxygen. Your cardiovascular system gets programmed to use oxygen more efficiently.

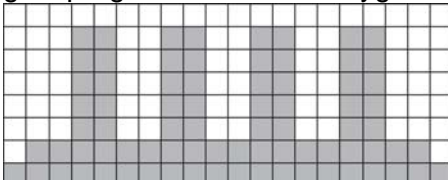

PROGRAMMING PRESET PROGRAMS

1. Select the desired program button then press the Enter key.
2. The Message Window will ask you to enter your Age. You may adjust the age setting, using the Up and Down keys, then press the Enter key to accept the new number and proceed on to the next screen.
3. You are now asked to enter your Weight. You may adjust the weight number using the Up and Down keys, then press Enter to continue.
4. Next is Time. You may adjust the Time and press Enter to continue.
5. Now you are asked to adjust the Max Level. This is the peak exertion level you will experience during the program (at the top of the hill). Adjust the level and then press Enter.
6. Now you are finished editing the settings and can begin your workout by pressing the Start key. You can also go back and modify your settings by pressing the Stop key to go back one level, or screen.
7. If you want to increase or decrease the workload at any time during the program press the Up or Down key. This will change the workload settings of the entire profile, although the profile picture on the screen will not change. The reason for this is so that you can see the entire profile at all times. If the profile picture is changed it will look distorted and not a true representation of the actual profile. When you make a change to the workload, the Message Window will show both the current column and program maximum levels of work.
8. During the program you will be able to scroll through the data in the Message Window by pressing the Scan key next to the Message Window.
9. When the program ends the Message Window and data windows will show a summary of your workout. The summary will be displayed for a short time then the console will return to the start-up display

HIIT PROGRAM

The HIIT, or High Intensity Interval Training, program takes advantage of the latest trend in fitness. During the program you will perform short bursts of high intensity sprinting followed by short rest periods. HIIT is a fully customizable interval training program. You can enter the number of intervals, time of each interval Sprint and Rest periods and the work intensity of the levels.

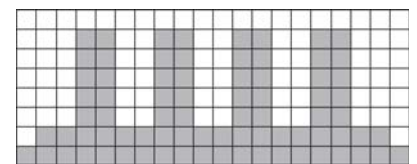

1. Press the HIIT key then Enter. The Message Window will ask you to enter your Age. You may enter your Age, using the Up and Down keys or the numeric key pad, then press the Enter key to accept the new number and proceed on to the next screen.
2. You are now asked to enter your Weight. You may adjust the Weight number using the Up and Down keys or the numeric key pad then press enter to continue.
3. Next you are asked for the number of intervals you want to do. The default is 10 and the range available is 3 to 15. One interval equals 1 Sprint and 1 Rest segment.
4. Now you are asked to adjust the Sprint Level. This is the resistance level you will experience during the Sprint segments of the program. Adjust the level and then press Enter.
5. Now you are asked to adjust the Rest Level. This is the resistance level you will experience during the Rest segments of the program. Adjust the level and then press Enter.

6. Next is entering the Interval time. The Message window shows: Sprint :30 | Rest :30. The Sprint time will be blinking. You may use the + - keys to adjust the Sprint time from 20 to 60 seconds then press Enter. The time for the Rest period will blink and you can adjust the time using the +- keys and press Enter.
7. The Message window will now display the total time for the HIIT workout; now press Start to begin. There is a 3-minute warm-up period before the first Sprint begins. The resistance level during warm-up is set to 5 but can be adjusted manually.
8. The dot matrix display in the HIIT program is a speed indication display, not a power or resistance display. During the Sprint the dot matrix display will show a blinking LED at the first Sprint segment. That is the target speed LED and indicates 90 pedal rpm. As you pedal faster the lights below the target speed LED light up the faster you go. When you exceed 90 rpm the target LED will move up showing you are past the target speed. You should maintain at least 90 rpm throughout the Sprint segments. The rest segments of the HIIT program are set to resistance level 5 and you can pedal at any speed you choose as your heart rate recovers. You can manually adjust the resistance levels during the Sprint and Rest segments.
9. At the end of the last Sprint there is a 3-minute cool-down period. You can bypass this by pressing the Stop key and the workout summary will be displayed.

CONSTANT WATT PROGRAM

The Watts program maintains a constant work load. The resistance Level adjusts when the speed is changed. To start the Constant Watt program, follow the instructions below or just press the Watt key then the Enter button and follow the directions in the Message Window.

1. Press the Watt key then press the Enter key.
2. The Message Window will ask you to enter your Age. Input your Age, using the Up/Down keys or the numeric key pad, then press the Enter key to accept the new age and proceed on to the next screen.
3. You are now asked to enter your Weight. Adjust Weight using the Up/Down keys or the numeric key pad, then press Enter to continue.
4. Next is Time. Adjust the Time then press Enter to continue.
5. Now you are asked to adjust the Target Watt Level. This is the constant power you will experience during the program. Adjust using the Up/Down keys, then press Enter.
6. Now you are finished editing the settings and can begin your workout by pressing the Start key. You can also go back and modify your settings by pressing the Enter key. *Note: At any time during the editing of data, you can press the Stop key to go back one level, or screen.*
7. If you want to increase or decrease the workload at any time during the program, press the Up/Down key. This will allow you to change your target Watt level at any time during the program.
8. During the Constant Power program you will be able to scroll through the data in the Message Window by pressing the adjacent Scan key.
9. When the program ends, you may press Start to begin the same program again or Stop to exit the program.

FIT TEST PROGRAM

The fitness test is based on the YMCA protocol and is a sub-maximal test that uses pre-determined, fixed work levels that are based on your heart rate readings as the test progresses. The test will take anywhere between 6 to 15 minutes to complete, depending on your level of fitness. The test ends when your heart rate reaches 85% of maximum at any time during the test or your heart rate is between 110 bpm and 85% at the end of two consecutive stages. At the end of the test a VO₂max score will be given. VO₂max stands for Volume of Oxygen uptake which is a measurement of how much oxygen you need to perform a known amount of work. The YMCA protocol uses two to four, 3-minute stages of continuous exercise. You will be asked to choose either, Male or Female at the beginning of the test. This choice determines which test parameters will be used during the test. The only caveats are that if you are a very de-conditioned Male you need to choose option Female. If you are a very conditioned female, you need to choose option Male.

FITNESS TEST PROGRAMMING

1. Press the Fit Test button and press Enter.
2. The message window will display Gender Male. The word Male will be blinking. Use the Up and Down arrows if you need to change to Female, then press Enter. The choice of Gender determines which workload chart will be used for the test.
3. The Message Window will ask you to enter your Age. You may adjust the age setting, using the Up and Down keys then press the Enter key to accept the new number and proceed on to the next screen.
4. You are now asked to enter your Weight. You may adjust the weight number using the Up and Down keys then press Enter to continue.
5. Now press Start to begin the test or Enter to modify your settings.

BEFORE THE TEST

- Make sure you are in good health; check with your physician before performing any exercise if you are over the age of 35 or persons with pre-existing health conditions.
- Adjust the seat to the proper position so that when your leg is extended during pedaling there is a slight bend at the knee of about 5 degrees.
- Make sure you have warmed up and stretched before taking the test.
- Do not take in caffeine before the test.

DURING THE TEST

- The console must be receiving a steady heart rate for the test to begin. You may use the hand pulse sensors or wear a heart rate chest strap transmitter.
- You must maintain a steady 50 rpm pedal speed. If your pedal speed drops below 48 rpm or goes above 52 rpm the console will emit a steady beeping sound until you are within this range.
- You may scroll through the various data readings in the Message Window by pressing the Display button under the Message Window.
- The Message Window will always display your pedal speed on the right side to help you maintain 50 rpm.
- The data shown during the test is:
 1. Work in KGM is actually an abbreviated form of kg-m/min. which is a work measurement of kilogram-force meter/minute
 2. Work in Watts (1 watt is equal to 6.11829727787 kg-m/min.)
 3. HR is your actual heart rate; TGT is the target heart rate to reach to end the test.
 4. Time is the total elapsed time of the test.

AFTER THE TEST

- Cool down for about one to three minutes.
- Take note of your score because the console will automatically return to the start-up mode after a few minutes.

WHAT YOUR SCORE MEANS

VO2max Chart for males and very fit females

	18-25 years old	26-35 years old	36-45 years old	46-55 years old	56-65 years old	65+ years old
excellent	>60	>56	>51	>45	>41	>37
good	52-60	49-56	43-51	39-45	36-41	33-37
above average	47-51	43-48	39-42	35-38	32-35	29-32
average	42-46	40-42	35-38	32-35	30-31	26-28
below average	37-41	35-39	31-34	29-31	26-29	22-25
poor	30-36	30-34	26-30	25-28	22-25	20-21
very poor	<30	<30	<26	<25	<22	<20

VO2max Chart for females and de-conditioned males

	18-25 years old	26-35 years old	36-45 years old	46-55 years old	56-65 years old	65+ years old
excellent	56	52	45	40	37	32
good	47-56	45-52	38-45	34-40	32-37	28-32
above average	42-46	39-44	34-37	31-33	28-31	25-27
average	38-41	35-38	31-33	28-30	25-27	22-24
below average	33-37	31-34	27-30	25-27	22-24	19-22
poor	28-32	26-30	22-26	20-24	18-21	17-18
very poor	<28	<26	<22	<20	<18	<17

HEART RATE PROGRAM

Heart rate information is read via pulse grips or wireless chest strap. To start the HR program, follow the instructions below or just press the HR key then the Enter button and follow the directions in the Message Window.

1. Press the HR key then press the Enter key.
2. The message window will ask you to enter your Age. You may enter your Age, using the Up/Down keys or the numeric key pad, then press the Enter key to accept the new number and proceed on to the next screen.
3. You are now asked to enter your Weight. You may adjust the Weight number using the Up/Down keys or the numeric key pad, then press Enter to continue.
4. Next is Time. You may adjust the Time and press Enter to continue.
5. Now you are asked to adjust your target Heart Rate. This is the heart rate level you will try to maintain during the program. Adjust the value and then press Enter.
6. Now you are finished editing the settings and can begin your workout by pressing the Start key. You can also go back and modify your settings by pressing the Enter key. *Note: At any time during the editing of data you can press the Stop key to go back one level, or screen.*
7. If you want to increase or decrease the resistance at any time during the program press the Up/Down key. This will allow you to change your target heart rate at any time during the program.
8. The program will automatically increase or decrease the amount of resistance, depending on whether your heart rate is above or below your target.
9. During the HR program you will be able to scroll through the data in the Message Window by pressing the adjacent Display key.

USING A HEART RATE TRANSMITTER (optional)

How to wear your wireless chest strap transmitter:

1. Attach the transmitter to the elastic strap using the locking parts.
2. Adjust the strap as tightly as possible as long as the strap is not too tight to remain comfortable.
3. Position the transmitter with the logo centered in the middle of your body facing away from your chest (some people must position the transmitter slightly left of center). Attach the final end of the elastic strap by inserting the round end and, using the locking parts, secure the transmitter and strap around your chest.
4. Position the transmitter immediately below the pectoral muscles.
5. Sweat is the best conductor to measure very minute heart beat electrical signals. However, plain water can also be used to pre-wet the electrodes (2 ribbed oval areas on the reverse side of the belt and both sides of the transmitter). It's also recommended that you wear the transmitter strap a few minutes before your work out. Some users, because of body chemistry, have a more difficult time in achieving a strong, steady signal at the beginning. After "warming up", this problem lessens. As noted, wearing clothing over the transmitter/strap doesn't affect performance.
6. Your workout must be within range - distance between transmitter/receiver – to achieve a strong steady signal. The length of range may vary somewhat but generally stay close enough to the console to maintain good, strong, reliable readings. Wearing the transmitter immediately against bare skin assures you of proper operation. If you wish, you may wear the transmitter over a shirt. To do so, moisten the areas of the shirt that the electrodes will rest upon.

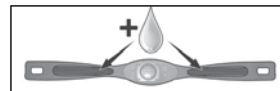

Note: The transmitter is automatically activated when it detects activity from the user's heart. Additionally, it automatically deactivates when it does not receive any activity. Although the transmitter is water resistant, moisture can have the effect of creating false signals, so you should take precautions to completely dry the transmitter after use to prolong battery life (estimated transmitter battery life is 2500 hours). The replacement battery is Panasonic CR2032.

ERRATIC OPERATION

Caution! Do not use this elliptical for Heart Rate Control unless a steady, solid Actual Heart Rate value is being displayed. High, wild, random numbers being displayed indicate a problem.

Areas to look at for interference, which may cause erratic heart rate:

1. Microwave ovens, TV's, small appliances, etc.
2. Fluorescent lights.
3. Some security systems.
4. Perimeter fence for a pet.
5. Some people have problems with the transmitter picking up a signal from their skin. If you have problems try wearing the transmitter upside down.
6. The antenna that picks up your heart rate is very sensitive. If there is an outside noise source, turning the whole machine 90 degrees may de-tune the interference.
7. Another Individual wearing a transmitter within 3' of your machine's console.

If you continue to experience problems contact Dyaco Canada Inc.

HEART RATE

A word about Heart Rate:

The old motto, “no pain, no gain”, is a myth that has been overpowered by the benefits of exercising comfortably. A great deal of this success has been promoted by the use of heart rate monitors. With the proper use of a heart rate monitor, many people find that their usual choice of exercise intensity was either too high or too low and exercise is much more enjoyable by maintaining their heart rate in the desired benefit range.

To determine the benefit range in which you wish to train, you must first determine your Maximum Heart Rate. This can be accomplished by using the following formula: 220 minus your age. This will give you the Maximum heart rate (MHR) for someone of your age. To determine the effective heart rate range for specific goals you simply calculate a percentage your MHR. Your Heart rate training zone is 50% to 90% of your maximum heart rate. 60% of your MHR is the zone that burns fat while 80% is for strengthening the cardio vascular system. This 60% to 80% is the zone to stay in for maximum benefit.

For someone who is 40 years old their target heart rate zone is calculated:

$220 - 40 = 180$ (maximum heart rate)
 $180 \times .6 = 108$ beats per minute (60% of maximum)
 $180 \times .8 = 144$ beats per minute (80% of maximum)

So for a 40 year old the training zone would be 108 to 144 beats per minute.

If you enter your age during programming the console will perform this calculation automatically. Entering your age is used for the Heart Rate control programs. After calculating your Maximum Heart Rate you can decide upon which goal you would like to pursue.

The two most popular reasons for, or goals, of exercise are cardiovascular fitness (training for the heart and lungs) and weight control. The black columns on the chart above represent the Maximum Heart Rate for a person whose age is listed at the bottom of each column. The training heart rate, for either cardiovascular fitness or weight loss, is represented by two different lines that cut diagonally through the chart. A definition of the lines' goal is in the bottom left-hand corner of the chart. If your goal is cardiovascular fitness or if it is weight loss, it can be achieved by training at 80% or 60%, respectively, of your Maximum Heart Rate on a schedule approved by your physician. Consult your physician before participating in any exercise program.

WARNING: Heart rate monitoring system may be inaccurate. Over exercise may result in injury or death. If you feel faint stop exercising immediately.

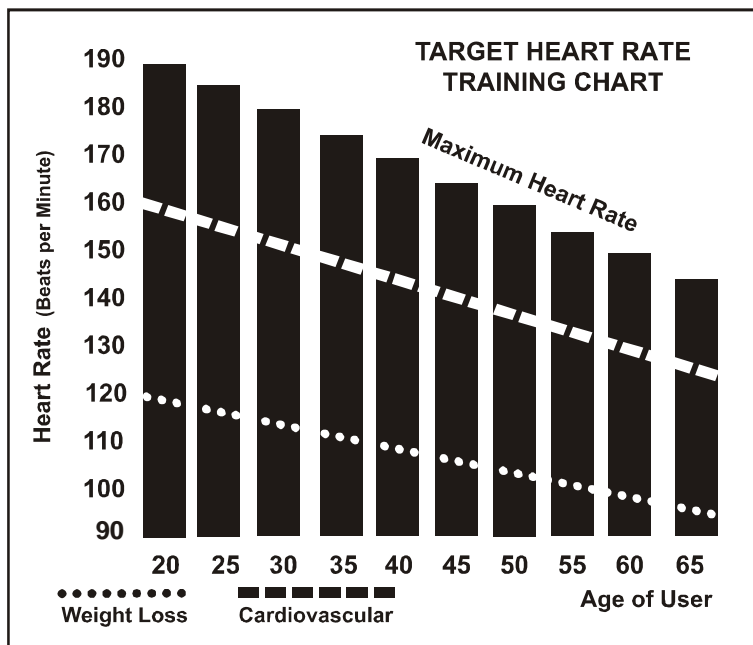

RATE OF PERCEIVED EXERTION

Heart rate is important but listening to your body also has a lot of advantages. There are more variables involved in how hard you should workout than just heart rate. Your stress level, physical health, emotional health, temperature, humidity, the time of day, the last time you ate and what you ate, all contribute to the intensity at which you should workout. If you listen to your body, it will tell you all of these things.

The rate of perceived exertion (RPE), also known as the Borg scale, was developed by Swedish physiologist G.A.V. Borg. This scale rates exercise intensity from 6 to 20 depending upon how you feel or the perception of your effort.

The scale is as follows:

Rating Perception of Effort

- 6 Minimal
- 7 Very, very light
- 8 Very, very light +
- 9 Very light
- 10 Very light +
- 11 Fairly light
- 12 Comfortable
- 13 Somewhat hard
- 14 Somewhat hard +
- 15 Hard
- 16 Hard +
- 17 Very hard
- 18 Very hard +
- 19 Very, very hard
- 20 Maximal

You can get an approximate heart rate level for each rating by simply adding a zero to each rating. For example a rating of 12 will result in an approximate heart rate of 120 beats per minute. Your RPE will vary depending up the factors discussed earlier. That is the major benefit of this type of training. If your body is strong and rested, you will feel strong and your pace will feel easier. When your body is in this condition, you are able to train harder and the RPE will support this. If you are feeling tired and sluggish, it is because your body needs a break. In this condition, your pace will feel harder. Again, this will show up in your RPE and you will train at the proper level for that day.

GENERAL MAINTENANCE

1. Wipe down all areas in the sweat path with a damp cloth after each workout.
2. If a squeak, thump, clicking or rough feeling develops the main cause is most likely one of two reasons:
 - 1) The hardware was not sufficiently tightened during assembly. All bolts that were installed during assembly need to be tightened as much as possible. It may be necessary to use a larger wrench than the one provided if you cannot tighten the bolts sufficiently. I cannot stress this point enough; 90% of calls to the service department for noise issues can be traced to loose hardware.
 - 2) The crank arm nut and/or the pedals need to be retightened.
3. If squeaks or other noises persist, check that the unit is properly leveled. There are 2 leveling pads on the bottom of the rear stabilizer, use a 14mm wrench (or adjustable wrench) to adjust the levelers.

Cleaning

Almost all surfaces are washable. A damp cloth is sufficient to clean most surfaces of this unit. Be careful not to drip water on the monitor. A mild liquid soap may be added if needed.

MAINTENANCE MODE MENU

The console has built-in maintenance/diagnostic software. The software will allow you to change the console settings from English to Metric and turn off the beeping of the speaker when a key is pressed for example. To enter the Maintenance Mode, pedal the bike and press and hold down the Start, Stop and Enter keys. Keep holding the keys down for about 5 seconds and the Message Center will display Maintenance Mode. Press the Enter key to access the menu below:

1. Key Test (Will allow you to test all the keys to make sure they are functioning)
2. Display Test (Tests all the display functions)
3. Sleep Mode (Turn on to have the console power down automatically after 20 minutes of inactivity)
4. Odometer Reset (Resets the odometer)
5. Units (Sets the display to read out in English or Metric display measurements)
6. Speaker (Turns off the speaker so no beeping sound is heard)
7. Brake Test (Tests the brake resistance)
8. Sensor Test (Tests the speed sensor function)
9. Unit Type (Sets machine type; Bike or Elliptical)
10. Bootloader
11. CSafe test (tests the CSafe functions)

If an error occurs while running a test, please hold the Stop button for 3 seconds to clear the error.

EXPLODED VIEW DIAGRAM

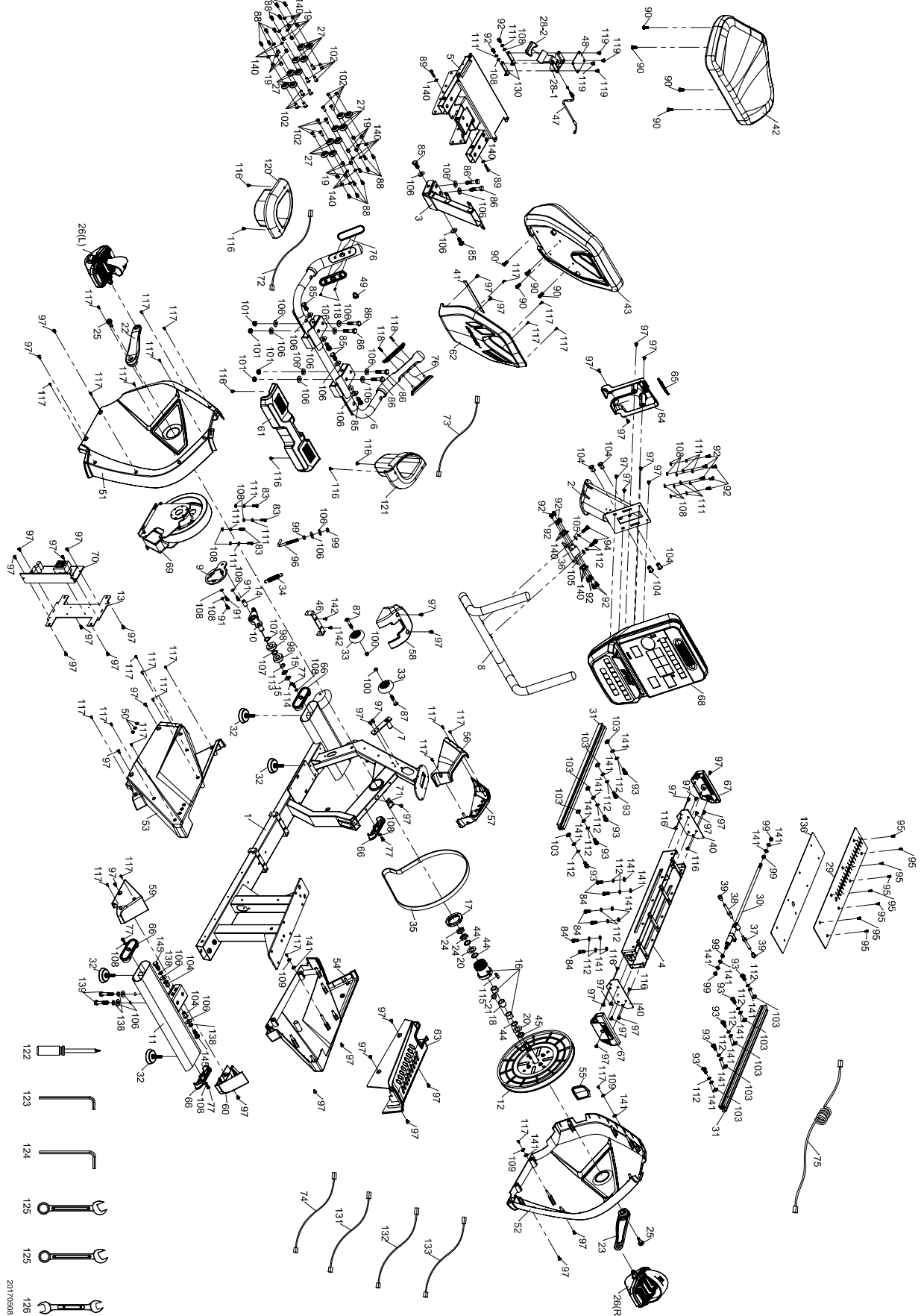

PARTS LIST

KEY NO	PART NO	DESCRIPTION	Q'TY
1	7890001	Main Frame	1
2	7890002	Console Mast	1
3	7890003	Seat Back Frame	1
4	7890004	Rail Assembly	1
5	7890005	Seat Carriage Frame	1
6	7890006	Rear Handlebar	1
7	7890007	Back-up Lever	1
8	7890008	Front Handlebar	1
9	7890009	Idler Bracket	1
10	7890010	Idler Wheel Assembly (Top)	1
11	7890011	Rear Stabilizer	1
12	7890012	Drive Pulley	1
13	7890013	Lower Controller Plate	1
14	7890014	Podwer metallurgy Sleeve	1
15	7890015	Ø10 x Ø25 x 0.8T_Nylon Washer	2
16	7890016	Bearing Bracket	1
17	7890017	M50 x P1.5 x 11T_Nut	1
18	7890018	Ring	1
19	7890019	Core	16
20	7890020	Plate	2
21	7890021	Ø15 x 7T_Magnet	1
22	7890022	Crank Arm(L)	1
23	7890023	Crank Arm(R)	1
24	7890024	M20 x P1.0 x 6T_Nut	2
25	7890025	M8 x P1.0 x 25L_Arbor Screw	2
26	7890026	Pedal(L,R)	1
27	7890027	PU Wheel	16
28~01	7890028-01	Release Lever	1
28~02	7890028-02	Nylon Handgrip	1
29	7890029	Iron Board	1
30	7890030	Shaft	1
31	7890031	Seat Front Read Adjusting	2
32	7890032	Adjustment Foot	4
33	7890033	Ø65_Transportation Wheel	2
34	7890034	Tension Spring, Idler Assembly	1
35	7890035	Drive Belt	1
36	7890036	Seat Stop Axle	1

KEY NO	PART NO	DESCRIPTION	Q'TY
37	7890037	Axle(Ø8.5x69.5L)	1
38	7890038	Axle(Ø8.5x73.5L)	1
39	7890039	Sleeve	2
40	7890040	Stopper Plate	2
41	7890041	Seat Cover Retaining Bracket	1
42	7890042	Seat	1
43	7890043	Seat Back	1
44	7890044	Back Plate	3
45	7890045	Axle Back Plate	1
46	7890046	Chain Cover Attaching Plate	1
47	7890047	Steel Cable	1
48	7890048	Handle Bar Back Plate	1
49	7890049	Ø7_HGP Wire Grommet	1
50	7890050	Block	3
51	7890051	Front Shroud (L)	1
52	7890052	Front Shroud (R)	1
53	7890053	Rear Shroud (L)	1
54	7890054	Rear Shroud (R)	1
55	7890055	Electronic Module	1
56	7890056	Console Mast Cover-L	1
57	7890057	Console Mast Cover-R	1
58	7890058	Front Stabilizer Cover	1
59	7890059	Rear Stabilizer Cover (L)	1
60	7890060	Rear Stabilizer Cover (R)	1
61	7890061	Rear Handlebar Cover	1
62	7890062	Seat Back Cover	1
63	7890063	Beam Cover	1
64	7890064	Console Bracket Cover	1
65	7890065	End Cap	1
66	7890066	Cap	4
67	7890067	Aluminum Axle End Cap	2
68	7890068	Console Assembly	1
69	7890069	Generator/Resistance	1
70	7890070	Generator/Brake Controller	1
71	7890071	1500m/m_Sensor W/Cable	1
72	7890072	680m/m_Handpulse Wire(SMP3)	1
73	7890073	800m/m_Handpulse Wire(SMR4)	1
74	7890074	2400m/m_Handpulse Wire	1

KEY NO	PART NO	DESCRIPTION	Q'TY
75	7890075	500m/m_Handpulse Wire	1
76	7890076	30m/m_Handpulse W/Cable Assembly	2
77	7890077	M5 x 15L_Phillips Head Screw	4
83	7890083	1/4" x UNC20 x 3/4" _Hex Head Bolt	4
84	7890084	M8 x 20m/m_Hex Head Bolt	6
85	7890085	M10 x P1.5 x 25L_Hex Head Bolt	8
86	7890086	M10 x 50m/m_Hex Head Bolt	6
87	7890087	5/16" x UNC18 x 1-3/4" _Button Head Socket Bolt	2
88	7890088	M6 x 15m/m_Button Head Socket Bolt	16
89	7890089	M6 x P1.0 x 30L_Button Head Socket Bolt	2
90	7890090	M8 x 20m/m_Button Head Socket Bolt	8
91	7890091	M5 x 15m/m_Socket Head Cap Bolt	3
92	7890092	M6 x P1.0 x 12L_Socket Head Cap Bolt	16
93	7890093	M8 x 20m/m_Socket Head Cap Bolt	10
94	7890094	M8 x 25m/m_Socket Head Cap Bolt	2
95	7890095	M5 x P0.8 x 12L_Flat Head Countersink Bolt	8
96	7890096	M8 x 80m/m_J Bolt	1
97	7890097	M5 x P0.8 x 12L_Phillips Head Screw	47
98	7890098	6203_Bearing	2
99	7890099	M8 x 6.3T_Nut	6
100	78900100	5/16 x 6T_Nyloc Nut	2
101	78900101	M10 x 8T_Nyloc Nut	4
102	78900102	M6 x 19L_Nut	16
103	78900103	M8 x 1.25 x 6.5T_Square Nut	10
104	78900104	M10 x 1.5m/m_Hex Blind Nut	6
105	78900105	Ø5/16" x Ø18 x 1.5T_Flat Washer	2
106	78900106	Ø3/8" x Ø25 x 2.0T_Flat Washer	22
107	78900107	Ø17 x Ø23.5 x 1.0T_Flat Washer	2
108	78900108	Ø1/4" x 13 x 1.0T_Flat Washer	19
109	78900109	Ø3/16" x Ø15 x 1.5T_Flat Washer	3
111	78900111	Ø1/4" _Split Washer	12
112	78900112	Ø5/16" x 1.5T_Split Washer	18
113	78900113	Ø17_C Ring	1
114	78900114	Ø10_C Ring	1
115	78900115	7 x 7 x 25m/m_Woodruff Key	1
116	78900116	4 x 12m/m_Sheet Metal Screw	10
117	78900117	3.5 x 12m/m_Sheet Metal Screw	26
118	78900118	3 x 20m/m_Tapping Screw	4

KEY NO	PART NO	DESCRIPTION	Q'TY
119	78900119	M6 x 10m/m_Thumb Head Socket Screw	4
120	78900120	Cup Holder (R)	1
121	78900121	Cup Holder (L)	1
122	78900122	Phillips Head Screwdriver	1
123	78900123	5 mm L Allen Wrench	1
124	78900124	6_L Allen Wrench	1
125	78900125	17m/m_Wrench	2
126	78900126	13/15m/m_Wrench	1
130	78900130	Handle Interface Board	2
131	78900131	2300m/m_Computer Cable	1
132	78900132	1200m/m_Generator Wire Harness	1
133	78900133	1000m/m_Wire Brake Coil Harness(Red)	1
136	78900136	Nylon Board	1
138	78900138	Ø10 x 1.5T_Split Washer	4
139	78900139	M10 x P1.5 x 55L_Hex Head Bolt	2
140	78900140	Ø1/4" x 13 x 1.0T_Flat Washer	26
141	78900141	Ø5/16" x 16 x 1.5T_Flat Washer	23
142	78900142	M5 x P0.8 x 12L_Tapping Screw	2
145	78900145	M10 x P1.5 x 30L_Hex Head Bolt	2

TRAINING GUIDELINES

EXERCISE

Exercise is one of the most important factors in the overall health of an individual. Listed among its benefits are:

- Increased capacity for physical work (strength endurance)
- Increased cardiovascular (heart and arteries/veins) and respiratory efficiency
- Decreased risk of coronary heart disease
- Changes in body metabolism, e.g. losing weight
- Delaying the physiological effects of age
- Physiological effects, e.g. reduction in stress, increase in self-confidence, etc.

BASIC COMPONENTS OF PHYSICAL FITNESS

There are four all encompassing components of physical fitness and we need to briefly define each and clarify its role.

Strength is the capacity of a muscle to exert a force against resistance. Strength contributes to power and speed and is of great importance to a majority of sports people.

Muscular Endurance is the capacity to exert a force repeatedly over a period of time, e.g. it is the capacity of your legs to carry you 10 Km without stopping.

Flexibility is the range of motion about a joint. Improving flexibility involves the stretching of muscles and tendons to maintain or increase suppleness, and provides increased resistance to muscle injury or soreness.

Cardio-Respiratory Endurance is the most essential component of physical fitness. It is the efficient functioning of the heart and lungs

AEROBIC FITNESS

The largest amount of oxygen that you can use per minute during exercise is called your maximum oxygen uptake (MVo₂). This is often referred to as your aerobic capacity.

The effort that you can exert over a prolonged period of time is limited by your ability to deliver oxygen to the working muscles. Regular vigorous exercise produces a training effect that can increase your aerobic capacity by as much as 20 to 30%. An increased MVO₂ indicates an increased ability of the heart to pump blood, of the lungs to ventilate oxygen and of the muscles to take up oxygen.

Anaerobic Training

This means “without oxygen” and is the output of energy when the oxygen supply is insufficient to meet the body’s long term energy demands. (For example, 100 meter sprint).

The Training Threshold

This is the minimum level of exercise which is required to produce significant improvements in any physical fitness parameter.

Progression

As you become fitter, a higher intensity of exercise is required to create an overload and therefore provide continued improvement

Overload

This is where you exercise at a level above that which can be carried out comfortably. The intensity, duration and frequency of exercise should be above the training threshold and should be gradually increased as the body adapts to the increasing demands. As your fitness level improves, so the training threshold should be raised.

Working through your program and gradually increasing the overload factor is important.

Specificity

Different forms of exercise produce different results. The type of exercise that is carried out is specific both to the muscle groups being used and to the energy source involved.

There is little transfer of the effects of exercise, i.e. from strength training to cardiovascular fitness. That is why it is important to have an exercise program tailored to your specific needs.

Reversibility

If you stop exercising or do not do your program often enough, you will lose the benefits you have gained. Regular workouts are the key to success.

WARM UP

Every exercise program should start with a warm up where the body is prepared for the effort to come. It should be gentle and preferably use the muscles to be involved later.

Stretching should be included in both your warm up and cool down, and should be performed after 3-5 minutes of low intensity aerobic activity or callisthenic type exercise.

Warm Down or Cool Down

This involves a gradual decrease in the intensity of the exercise session. Following exercise, a large supply of blood remains in the working muscles. If it is not returned promptly to the central circulation, pooling of blood may occur in the muscles

Heart Rate

As you exercise, so the rate at which your heart beat also increases. This is often used as a measure of the required intensity of exercise. You need to exercise hard enough to condition your circulatory system, and increase your pulse rate, but not enough to strain your heart.

Your initial level of fitness is important in developing an exercise program for you. If you are starting off, you can get a good training effect with a heart rate of 110-120 beats per minute (BPM). If you are fitter, you will need a higher threshold of stimulation.

To begin with, you should exercise at a level that elevates your heart rate to about 65 to 70% of your maximum. If you find this is too easy, you may want to increase it, but it is better to lean on the conservative side.

As a rule of thumb, the maximum heart rate is 220 minus your age. As you increase in age, so your heart, like other muscles, loses some of its efficiency. Some of its natural loss is won back as fitness improves.

The following table is a guide to those who are “starting fitness”.

Age	25	30	35	40	45	50	55	60	65
Target heart Rate 10 Second Count	23	22	22	21	20	19	19	18	18
Beats per Minute	138	132	132	126	120	114	114	108	108

Pulse Count

The pulse count (on your wrist or carotid artery in the neck, taken with two index fingers) is done for ten seconds, taken a few seconds after you stop exercising. This is for two reasons: (a) 10 seconds is long enough for accuracy, (b) the pulse count is to approximate your BPM rate at the time you are exercising. Since heart rate slows as you recover, a longer count isn't as accurate.

The target is not a magic number, but a general guide. If you're above average fitness, you may work quite comfortably a little above that suggested for your age group.

The following table is a guide to those who are keeping fit. Here we are working at about 80% of maximum.

Age	25	30	35	40	45	50	55	60	65
Target heart Rate 10 Second Count	26	26	25	24	23	22	22	21	20
Beats per Minute	156	156	150	144	138	132	132	126	120

Don't push yourself too hard to reach the figures on this table. It can be very uncomfortable if you overdo it. Let it happen naturally as you work through your program. Remember, the target is a guide, not a rule, a little above or below is just fine.

Two final comments:(1) don't be concerned with day to day variations in your pulse rate, being under pressure or not enough sleep can affect it;(2) your pulse rate is a guide, don't become a slave to it.

ENDURANCE CIRCUIT TRAINING

Cardiovascular endurance, muscle, strength, flexibility and coordination are all necessary for maximum fitness. The principle behind circuit training is to give a person all the essentials at one time by going through your exercise program moving as fast as possible between each exercise. This increases the heart rate and sustains it, which improves the fitness level. Do not introduce this circuit training effect until you have reached an advanced program stage.

Body Building

Is often used synonymously with strength training. The fundamental principal here is OVERLOAD. Here, the muscle works against greater loads than usual. This can be done by increasing the load you are working against.

Patronization

This is the term used to vary your exercise program for both physiological and psychological benefits. In your overall program, you should vary the workload, frequency and intensity. The body responds better to variety and so do you. In addition, when you feel yourself getting "stale", bring in periods of lighter exercise to allow the body to recuperate and restore its reserves. You will enjoy your program more and feel better for it.

Muscle Soreness

For the first week or so, this may be the only indication you have that you are on an exercise program. This, of course, does depend on your overall fitness level. A confirmation that you are on the correct program is a very slight soreness in most major muscle groups. This is quite normal and will disappear in a matter of days.

If you experience major discomfort, you may be on a program that is too advanced or you have increased your program too rapidly.

If you experience PAIN during or after exercise, your body is telling you something. Stop exercising and consult your doctor.

WHAT TO WEAR

Wear clothing that will not restrict your movement in any way while exercising. Clothes should be light enough to allow the body to cool. Excessive clothing that causes you to perspire more than you normally would while exercising, gives you no advantage. The extra weight you lose is body fluid and will be replaced with the next glass of water you drink. It is advisable to wear a pair of gym or running shoes or "sneakers".

Breathing During Exercise

Do not hold your breath while exercising. Breathe normally as much as possible. Remember, breathing involves the intake and distribution of oxygen, which feeds the working muscles.

Rest periods

Once you start your exercise program, you should continue through to the end. Do not break off halfway through and then restart at the same place later on without going through the warm-up stage again.

The rest period required between strength training exercises may vary from person to person. This will depend mostly on your level of fitness and the program you have chosen. Rest between exercises by all means, but do not allow this to exceed two minutes. Most people manage with half minute to one minute rest periods.

STRETCHING

Stretching should be included in both your warm up and cool down, and should be performed after 3-5 minutes of low intensity aerobic activity or callisthenic type exercise. Movements should be performed slowly and smoothly, with no bouncing or jerking. Move into the stretch until slight tension, not pain, is felt in the muscle and hold for 20-30 seconds. Breathing should be slow, rhythmical and under control, making sure never to hold your breath.

HEAD ROLLS

Rotate your head to the right for one count, feeling the stretch up the left side of your neck. Next rotate your head back for one count, stretching your chin to the ceiling and letting your mouth open. Rotate your head to the left for one count, and finally, drop your head to your chest for one count.

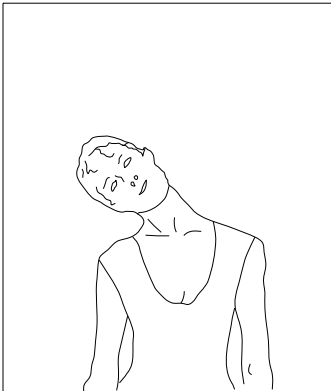

SHOULDER LIFTS

Lift your right shoulder up toward your ear for one count. Then lift your left shoulder up for one count as you lower your right shoulder.

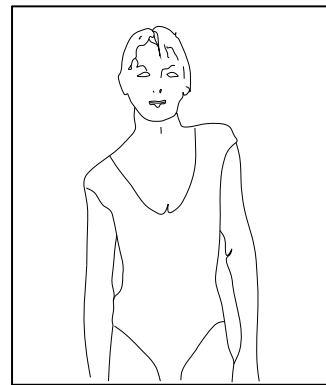

SIDE STRETCHES

Open your arms to the side and continue lifting them until they are over your head. Reach your right arm as far upward toward the ceiling as you can for one count. Feel the stretch up your right side. Repeat this action with your left arm.

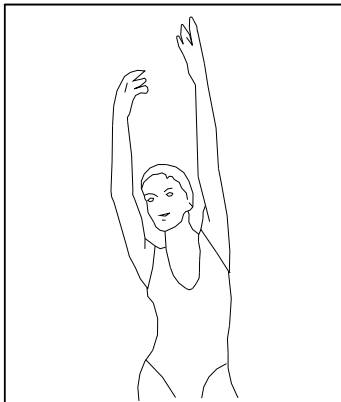

QUADRICEPS STRETCH

With one hand against a wall for balance, reach behind you and pull your right foot up. Bring your heel as close to your buttocks as possible. Hold for 15 counts and repeat with left foot up.

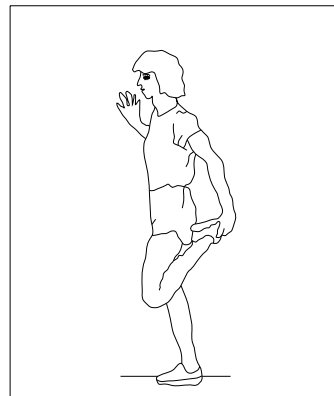

INNER THIGH STRETCH

Sit with the soles of your feet together with your knees pointing outward. Pull your feet as close into your groin as possible. Gently push your knees towards the floor. Hold for 15 counts.



TOUCHES

Slowly bend forward from your waist, letting your back and shoulders relax as you stretch toward your toes. Reach down as far as you can and hold for 15 counts.

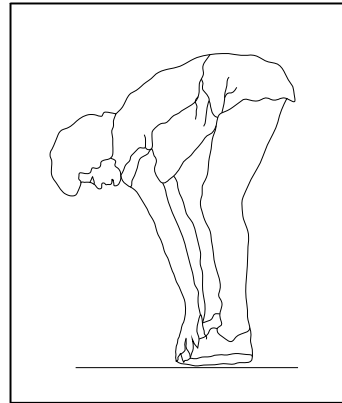

HAMSTRING STRETCHES

Sit with your right leg extended. Rest the sole of your left foot against your right inner thigh. Stretch as far as possible. Hold for 15 counts. Relax and then repeat with left leg extended.

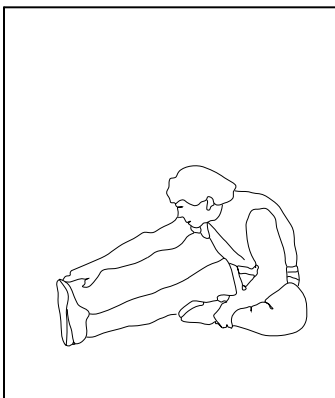

CALF / ACHILLES STRETCH

Lean against a wall with your left leg in front of the right and your arms forward. Keep toward your toe your right leg straight and the left foot on the floor then bend the left leg and lean forward by moving your hips toward the wall. Hold, then repeat on the other side for 15 counts.

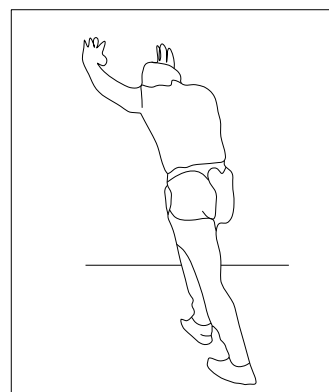

MANUFACTURER'S LIMITED WARRANTY

Dyaco Canada Inc. warrants all its bike parts for a period of time listed below, from the date of retail sale, as determined by a sales receipt. Dyaco Canada Inc.'s responsibilities include providing new or remanufactured parts, at Dyaco Canada Inc.'s option, and technical support to our independent dealers and servicing organizations. In the absence of a dealer or service organization, these warranties will be administered by Dyaco Canada Inc. directly to the facility. The warranty period applies to the following components:

Commercial Warranty (All Facilities)

Frame	Lifetime
Brake	5 Years
Parts	3 Years
Labour	3 Years

This warranty is not transferable and is extended only to the original owner.

NORMAL RESPONSIBILITIES OF THE FACILITY

The facility is responsible for the items listed below:

1. The warranty registration card must be completed and returned to the address listed on the card within 10 days of the original purchase.
2. Proper use of the bike in accordance with the instructions provided in this manual.
3. Expenses for making the bike accessible for servicing, including any item that was not part of the bike at the time it was shipped from the factory.
4. Damages to the bike finish during shipping, installation or following installation.
5. Routine maintenance of this unit as specified in this manual.

EXCLUSIONS

This warranty does not cover the following:

1. CONSEQUENTIAL, COLLATERAL, OR INCIDENTAL DAMAGES SUCH AS PROPERTY DAMAGE AND INCIDENTAL EXPENSES RESULTING FROM ANY BREACH OF THIS WRITTEN OR ANY IMPLIED WARRANTY.
Note: Some areas do not allow the exclusion or limitation of incidental or consequential damages, so this limitation or exclusion may not apply to you.
2. Service call reimbursement to the facility. Service call reimbursement to the dealer that does not involve malfunction or defects in workmanship or material, for units that are beyond the warranty period, for units that are beyond the service call reimbursement period, for bike not requiring component replacement.
3. Damages caused by services performed by persons other than authorized Dyaco Canada Inc. service companies; use of parts other than original Dyaco Canada Inc. parts; or external causes such as corrosion, discoloration of paint or plastic, alterations, modifications, abuse, misuse, accident, improper maintenance, inadequate power supply, or acts of God.
4. Products with original serial numbers that have been removed or altered.
5. Products that have been: sold, transferred, bartered, or given to a third party.
6. Products that do not have a warranty registration card on file at Dyaco Canada Inc. Dyaco Canada Inc. reserves the right to request proof of purchase if no warranty record exists for the product.
7. THIS WARRANTY IS EXPRESSLY IN LIEU OF ALL OTHER WARRANTIES EXPRESSED OR IMPLIED, INCLUDING THE WARRANTIES OF MERCHANTABILITY AND/OR FITNESS FOR A PARTICULAR PURPOSE.
8. Warranties outside of Canada may vary. Please contact your local dealer or Dyaco Canada for details.

SERVICE

The sales receipt establishes the labour warranty period should service be required. If service is performed, it is in your best interest to obtain and keep all receipts. This written warranty gives you specific legal rights. Service under this warranty must be obtained by following these steps, in order:

1. Contact your selling authorized dealer or Dyaco Canada.
2. If you have any questions about your new product or questions about the warranty contact Dyaco Canada Inc. at 1-888-707-1880.
3. If no local service is available, Dyaco Canada Inc. will repair or replace the parts, at Dyaco Canada Inc.'s option, within the warranty period at no charge for parts. All transportation costs, both to our factory and upon return to the facility, are the responsibility of the facility. The facility is responsible for adequate packaging upon return to Dyaco Canada Inc. Dyaco Canada Inc. is not responsible for damages that occur during shipping. Make all freight damage claims with the appropriate freight carrier. DO NOT SHIP ANY UNIT TO OUR FACTORY WITHOUT A RETURN AUTHORIZATION NUMBER. All units arriving without a return authorization number will be refused.
4. For any further information, or to contact our service department by mail, send your correspondence to:

Dyaco Canada Inc.
5955 Don Murie Street
Niagara Falls, ON
L2G 0A9

Product features or specifications as described or illustrated are subject to change without notice. All warranties are made by Dyaco Canada Inc.



Please visit us online for information about our other brands and products manufactured and distributed by Dyaco Canada Inc.



www.dyaco.ca



www.dyaco.ca



www.dyaco.ca



www.dyaco.ca



www.spiritfitnesscanada.ca
www.dyaco.ca



www.spiritfitnesscanada.ca
www.dyaco.ca



www.solefitness.ca
www.dyaco.ca



www.trainorsports.ca
www.dyaco.ca



www.xterrafitness.ca
www.dyaco.ca

