

OWNER'S MANUAL

MODEL NO.
16607008000

- Assembly
- Operation
- Maintenance
- Parts
- Warranty

CAUTION:

You must read and understand this owner's manual before operating unit.

SPIRIT



TABLE OF CONTENTS

PRODUCT REGISTRATION.....	2
SAFETY PRECAUTIONS.....	3
ASSEMBLY INSTRUCTIONS.....	6
TRANSPORT & LUBRICATION.....	13
GETTING ON / OFF YOUR ELLIPTICAL.....	14
OPERATION OF YOUR CONSOLE.....	16
MAINTENANCE.....	31
PARTS LIST & DIAGRAM.....	32
TRAINING GUIDELINES.....	36
STRETCHING.....	40
MANUFACTURER'S LIMITED WARRANTY.....	42

SPIRIT

**CONGRATULATIONS ON YOUR
NEW ELLIPTICAL**

CONGRATULATIONS ON YOUR NEW ELLIPTICAL

Thank you for your purchase of this quality elliptical from Dyaco Canada Inc. Your new elliptical was manufactured by one of the leading fitness manufacturers in the world and is backed by one of the most comprehensive warranties available. Through your dealer, Dyaco Canada Inc. will do all we can to make your ownership experience as pleasant as possible for many years to come. The local dealership where you purchased this elliptical is your administrator for all warranty and service needs. Their responsibility is to provide you with the technical knowledge and service personnel to make your experience more informed and any difficulties easier to remedy.

Please take a moment at this time to record the name of the dealer, their telephone number, and the date of purchase below to make any future, needed contact easy. We appreciate your support, and we will always remember that you are the reason that we are in business. Please go to www.dyaco.ca/warranty.html and complete the online warranty registration.

Yours in Health,
Dyaco Canada Inc.

Name of Dealer: _____

Telephone Number of Dealer: _____

Purchase Date: _____

Product Registration

RECORD YOUR SERIAL NUMBER

Please record the Serial Number of this fitness product in the space provided below.

Serial Number: _____

REGISTER YOUR PURCHASE

Please visit us at www.dyaco.ca/warranty.html to register your purchase.

SAFETY PRECAUTIONS

IMPORTANT SAFETY INFORMATION READ ALL INSTRUCTIONS BEFORE USING THIS ELLIPTICAL

CAUTION: Before starting any exercise program, it is recommended that you consult your physician.

Thank you for purchasing our product. Even though we go to great efforts to ensure the quality of each product we produce, occasional errors and/or omissions do occur. In any event should you find this product to have either a defective or a missing part please contact us for a replacement.

This exercise equipment was designed and built for optimum safety. However, certain precautions apply whenever you operate a piece of exercise equipment. Be sure to read the entire manual before assembly and operation of this machine. Also, please note the following safety precautions:

1. Read the OWNER'S OPERATING MANUAL and all accompanying literature and follow it carefully before using your elliptical.
2. It is the responsibility of the owner to ensure that all users of the elliptical exerciser are adequately informed of all precautions.
3. If dizziness, nausea, chest pains, or any other abnormal symptoms are experienced while using this equipment, STOP the workout at once. CONSULT A PHYSICIAN IMMEDIATELY.
4. Inspect your exercise equipment prior to exercising to ensure that all nuts and bolts are fully tightened before each use.
5. The elliptical must be regularly checked for signs of wear and damage. Any part found defective, the part must be replaced with new spare part from the manufacturer.
6. Fitness equipment must always be installed on a flat surface, do not place the unit on a loose rug or uneven surface. It is recommended to use an equipment mat to prevent the unit from moving while it is being used, which could possibly scratch or damage the surface of your floor. Keep the elliptical exerciser indoors, away from moisture and dust.
7. No changes must be made which might compromise the safety of the equipment.
8. It is recommended to have a minimum of 1' safe clearance around the exercise equipment while in use.
9. Keep children and pets away from this equipment at all times while exercising.
10. Warm up 5 to 10 minutes before each workout and cool down 5 to 10 minutes afterward. This allows your heart rate to gradually increase and decrease and will help prevent you from straining muscles.
11. Never hold your breath while exercising. Breathing should remain at a normal rate in conjunction with the level of exercise being performed
12. Always wear suitable clothing and footwear while exercising. Do not wear loose fitting clothing that could become entangled with the moving parts of your elliptical.
13. Always hold the handlebars when mounting, dismounting, or using the elliptical exerciser.
14. Keep your back straight when using the elliptical exerciser; do not arch your back.

WARNING: Before beginning any exercise program consult your physician. This is especially important for individuals over the age of 35 or persons with pre-existing health problems. Read all instructions before using any fitness equipment. We assume no responsibility for personal injury or property damage sustained by or through the use of this product.

SAVE THESE INSTRUCTIONS

IMPORTANT SAFETY INSTRUCTIONS

WARNING - Read all instructions before using this equipment.

DANGER - To reduce the risk of electric shock, always unplug this equipment from the electrical outlet immediately after using and before cleaning.

- Do not operate Elliptical on deeply padded, plush or shag carpet. Damage to both carpet and Elliptical may result.
- Keep children away from the Elliptical. There are obvious pinch points and other caution areas that can cause harm.
- Keep hands away from all moving parts.
- Do not operate where aerosol spray products are being used or where oxygen is being administered. Sparks from the motor may ignite a highly gaseous environment.
- Never drop or insert any object into any openings.
- Do not use outdoors.
- Do not attempt to use your Elliptical for any purpose other than for the purpose it is intended.
- The hand pulse sensors are not medical devices. Various factors, including the user's movement, may affect the accuracy of heart rate readings. The pulse sensors are intended only as exercise aids in determining heart rate trends in general.
- Wear proper shoes. High heels, dress shoes, sandals or bare feet are not suitable for use on your climber. Quality athletic shoes are recommended to avoid leg fatigue.
- Keep children under the age of 13 away from this machine.
- This exercise equipment is not intended for use by persons with reduced physical, sensory or mental capabilities, or lack of experience and knowledge.
- Before beginning this or any exercise program, consult a physician. This is especially important for persons over the age of 35 or persons with pre-existing health conditions.
- Close supervision is necessary when this exercise equipment is used by, on, or near children, invalids, or disabled persons.

SAVE THESE INSTRUCTIONS - THINK SAFETY!

IMPORTANT ELECTRICAL INSTRUCTIONS

WARNING!

Be aware that the generator is producing A.C. power while the elliptical trainer is being used. Do not service the elliptical trainer while the generator is spinning; serious electric shock could occur.

NEVER expose this elliptical trainer to rain or moisture. This product is **NOT** designed for use outdoors, near a pool or spa, or in any other high humidity environment. The operating temperature specification is 5 to 48 degrees Celsius (40 to 120 degrees Fahrenheit), and humidity is 95% non-condensing (no water drops forming on surfaces).

Important Operation Instructions

- **NEVER** operate this elliptical without reading and completely understanding the results of any operational change you request from the computer.
- **All users** should have medical clearance before starting any rigorous exercise program. This is especially important for persons with a history of heart disease or other high risk factors.
- Understand that changes in resistance do not occur immediately. Set your desired resistance level on the computer console and release the adjustment key. The computer will obey the command gradually.
- Use caution while participating in other activities while pedaling on your elliptical; such as watching television, reading, etc. These distractions may cause you to lose balance which may result in serious injury.
- Always hold on to a handle bar while making control changes.
- Do not use excessive pressure on console control keys. They are precision set to function properly with little finger pressure. If you feel the buttons are not functioning properly with normal pressure contact your dealer.

ASSEMBLY INSTRUCTIONS

UNPACKING

1. Cut the straps, then lift the box over the unit and unpack.
2. Locate the hardware package. The hardware is separated into four steps. Remove the tools first. Remove the hardware for each step as needed to avoid confusion. The numbers in the instructions that are in parenthesis (#) are the item number from the assembly drawing for reference.

ASSEMBLY TOOLS

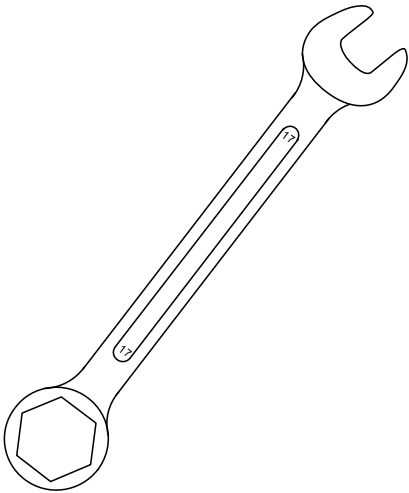

#125. 17 mm
Wrench (1 pc)

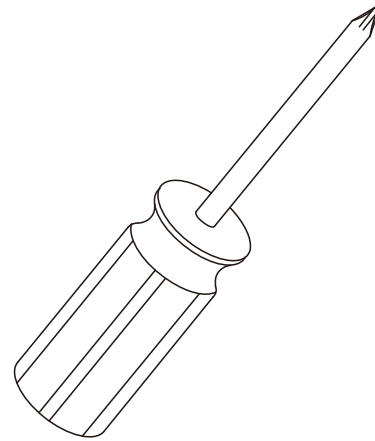

#126. Phillips Head
Screw driver (1 pc)

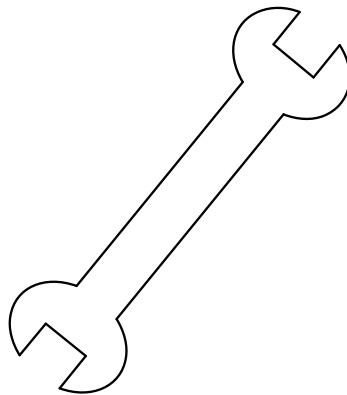

#122. 13/14 mm
Wrench (1 pc)

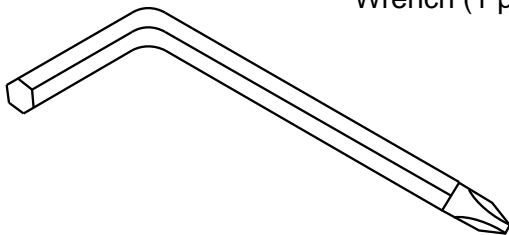

#123. Combination M6 Allen Wrench &
Phillips Head Screw (1 pc)

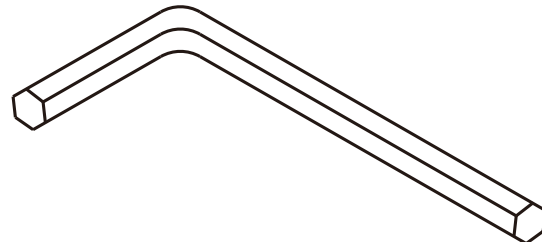

#124. M12_L Allen Wrench (1 pc)

Step 1

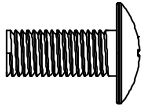

#78 - M5 x 12mm
Phillips Head Screw (4 pcs)

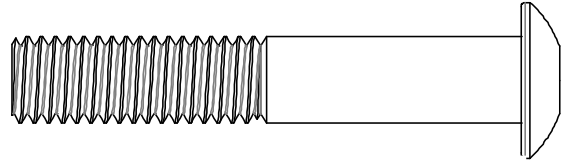

#106 - 3/8" x 2-1/4"
Stainless Steel Bolt (4 pcs)

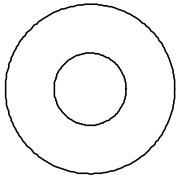

#109 - 3/8"
Flat Washer (4 pcs)

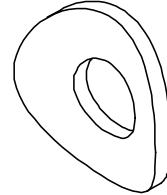

#108 - 3/8"
Curved Washer (6 pcs)

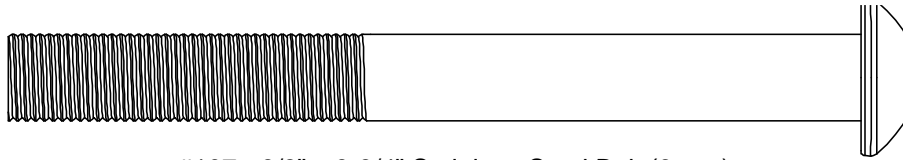

#107 - 3/8" x 3-3/4" Stainless Steel Bolt (6 pcs)

Step 2

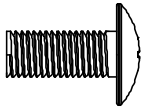

#78 - M5 x 12mm
Phillips Head Screw (4 pcs)

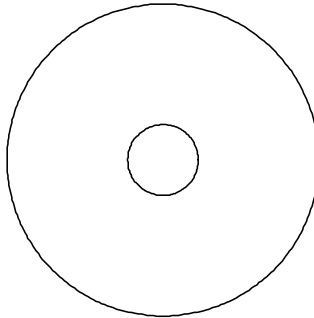

#87 - 5/16" Flat Washer (2 pcs)

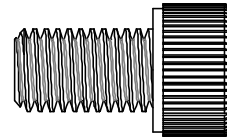

#97 - 5/16" x 15mm
Bolt W / Loctite (2 pcs)

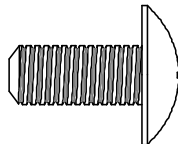

#103 - M6 x 15mm
Phillips Head Screw (2 pcs)

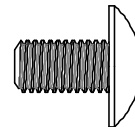

#110 - M5 x 10mm
Phillips Head Screw
W / Loctite (8 pcs)

Step 3

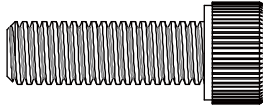

#75 - M8 x 25mm
Socket Cap Bolt (4 pcs)

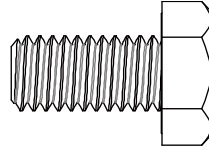

#117 - 3/8"x 3/4"
Hex Head Bolt
W / Loctite (2 pcs)

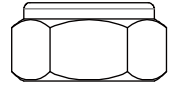

#118 - M10
Nylon Nut (2 pcs)

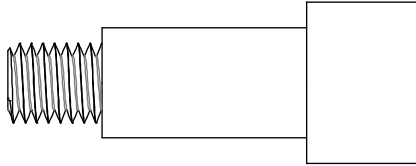

#119 - M10 x 14mm
Shoulder Bolt (2 pcs)

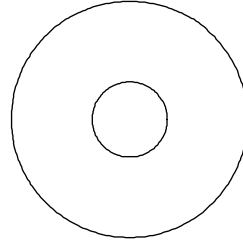

#120 - 3/8"
Flat Washer (2 pcs)



#113 - 3.5mm x 12mm
Sheet Metal Screw (4 pcs)



#148 - 25mm
Wave Washer (2 pcs)

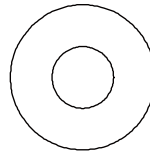

#88 - 5/16"
Flat Washer (1 pcs)

Step 4

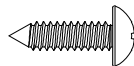

#113 - 3.5 x 12mm
Sheet Metal Screw (14 pcs)

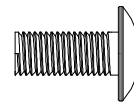

#78 - M5 x 12mm
Phillips Head Screw (14 pcs)

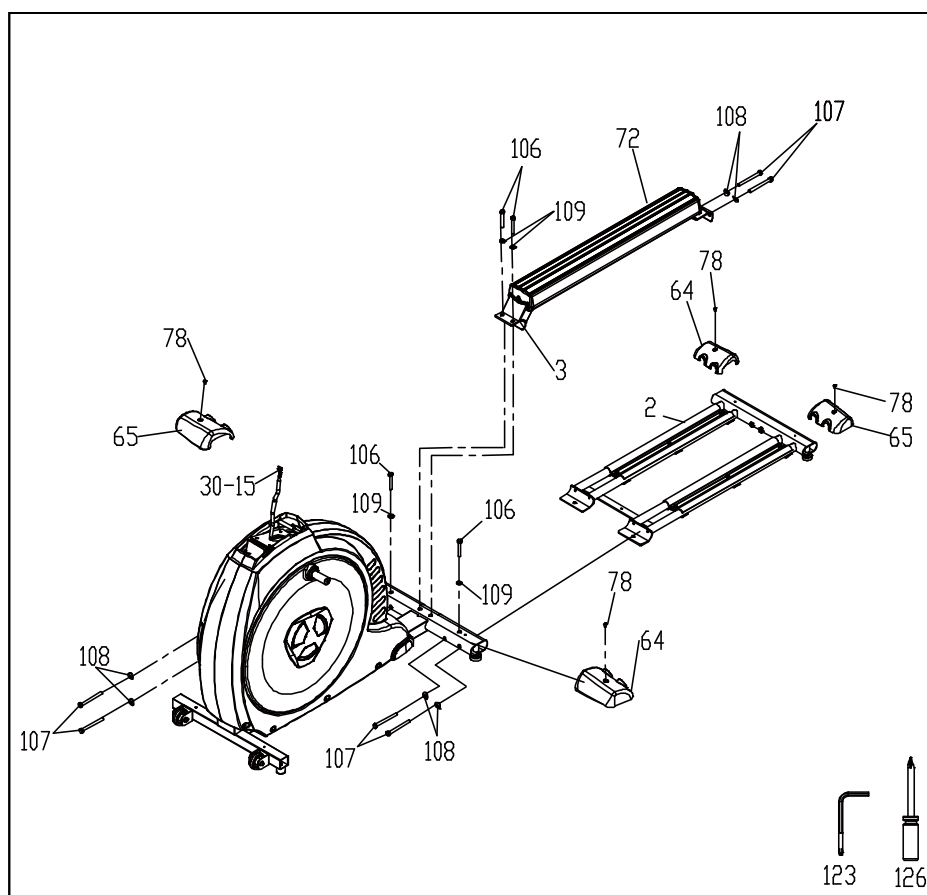

STEP 1

1. Gather **HARDWARE FOR STEP 1**.
2. Slide the **RAIL ASSEMBLY (2)** under the rear oval stabilizer tube of the main frame. Secure together with 2 **BOLTS (106)** and 2 **WASHERS (109)** from the top of the tube and 4 **BOLTS (107)** and 4 **CURVED WASHERS (108)** from the front of the tube. Make sure all 6 **BOLTS** are tightened securely.
3. Install the **CENTER ALUMINUM RAIL (72)** with 2 **BOLTS (107)** and 2 **CURVED WASHERS (108)** at the rear and 2 **BOLTS (106)** and 2 **WASHERS (109)** at the front.
4. Install the 2 **TUBE STABILIZER COVERS (64 LEFT & 65 RIGHT)** with 2 **SCREWS (78)** to the middle **STABILIZER TUBE** and the 2 **STABILIZER COVERS (65 left & 64 right)** with 2 **SCREWS (78)** to the rear stabilizer tube.

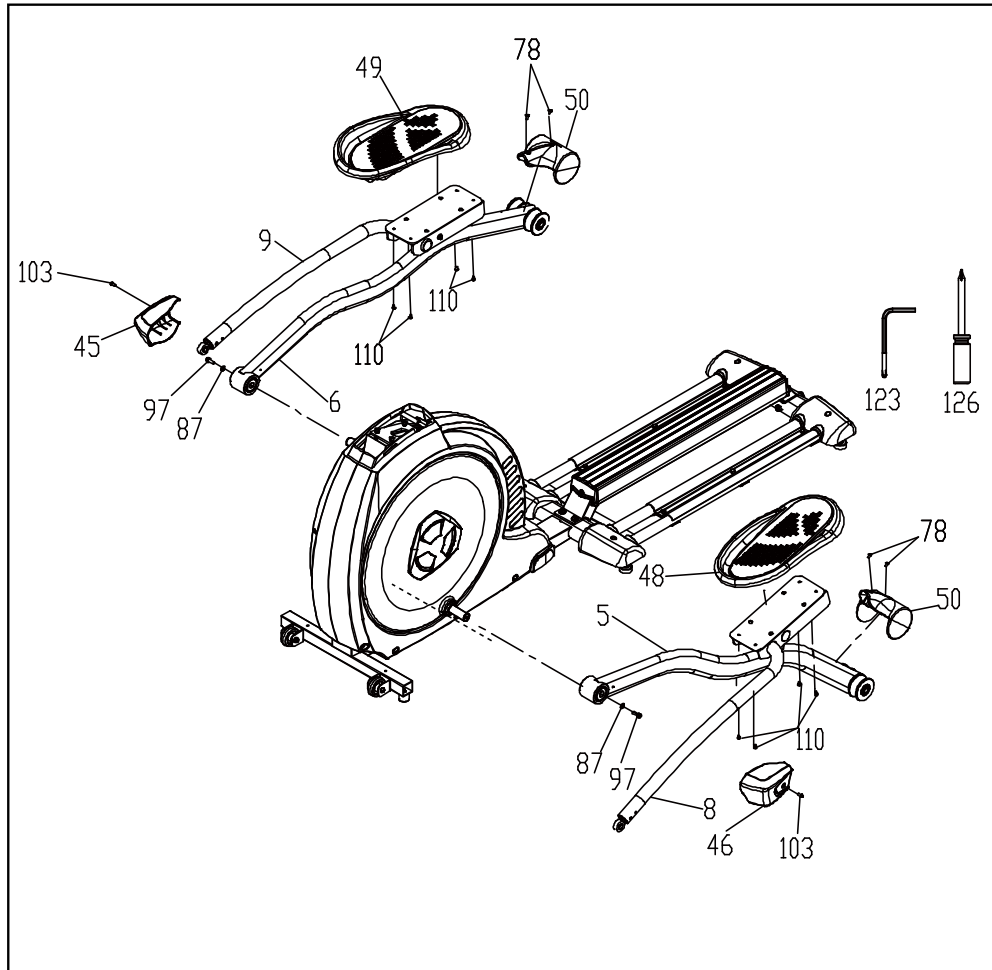

STEP 2

1. Gather **HARDWARE FOR STEP 2**.
2. Attach **FOOTPLATES (L 48)** to the pedal mounting plate with 4 **SCREWS (110)**.
3. Slide the **PEDAL ARM** assembly (5) onto the crank axle of the main body. Be careful not to force it because damage to the bearings can occur. Secure with a **BOLT (97)** and **WASHER (87)**.
4. Install the **COVER (46)** over the pedal arm connection at the rotation axle with a **SCREW (103)**.
5. Install the **ROLLER WHEEL COVER (50)** with 2 **SCREWS (78)**.
6. Repeat all steps with the opposite **PEDAL ARM** assembly (6).

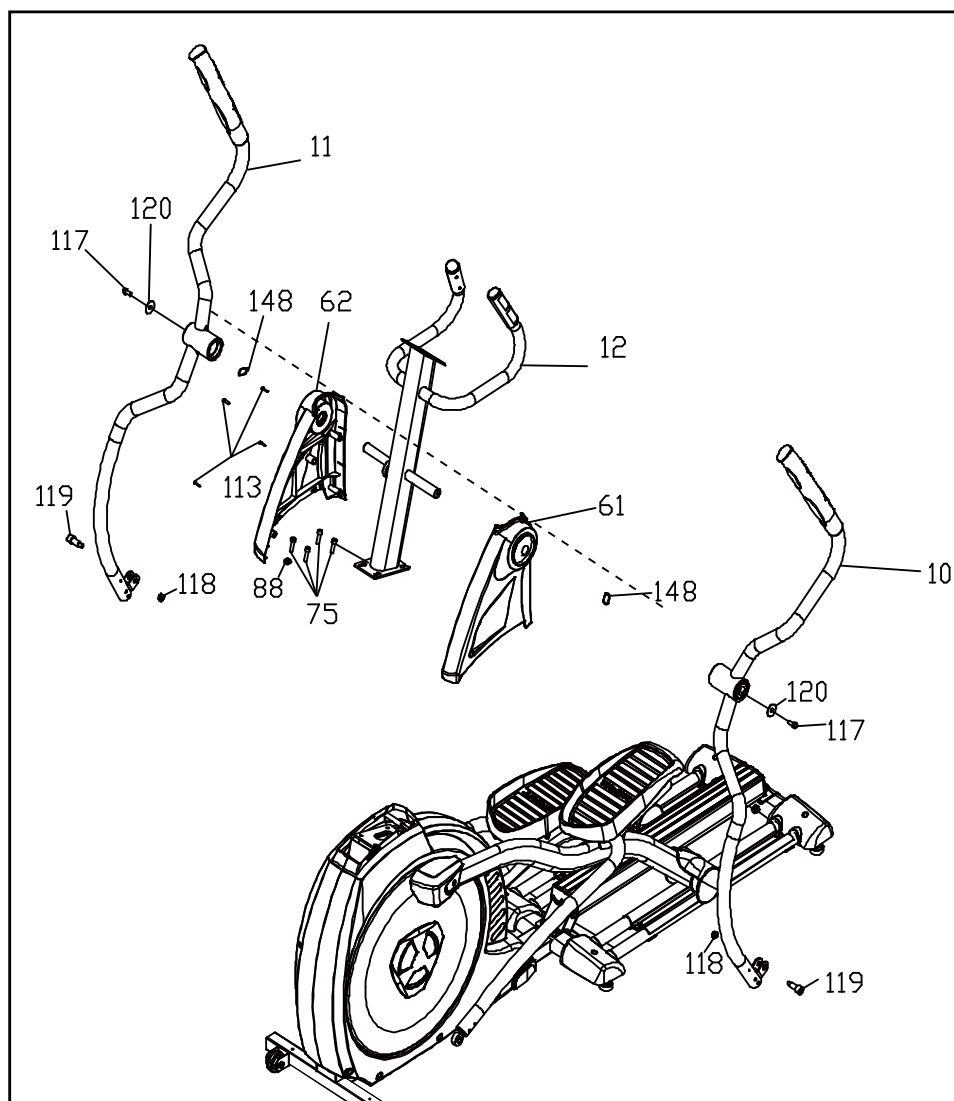

STEP 3

1. Gather **HARDWARE FOR STEP 3**.
2. Unravel the **COMPUTER CABLE (30-15)** and snake it through the bottom of the **CONSOLE MAST (12)** and out the top. To install mast tube (12), first insert three M8x25mm screws (75) onto the mainframe then locate the mast tube (12) on its position and tighten three screws. Now the last M8x25mm screw (75) must be with 5/16" flat washer (88) to tighten to the screw hole.
3. Mount the **CONSOLE MAST COVERS (L 61) (R62)** with 4 **SCREWS (113)**.
4. Install 2 **WAVE WASHERS (148)** onto the **CONSOLE MAST AXLE** then install the **SWING ARMS (L10)(R11)** onto the axles. Do not force them or use a hammer as damage to the bearings can occur. Secure with a **BOLT (117)** and **WASHER (120)** on each arm.
5. Attach the bottom of the swing arms to the rod ends of the pedal arms using 2 **SHOULDER BOLTS (119)** and 2 **NYLON NUTS (118)**.

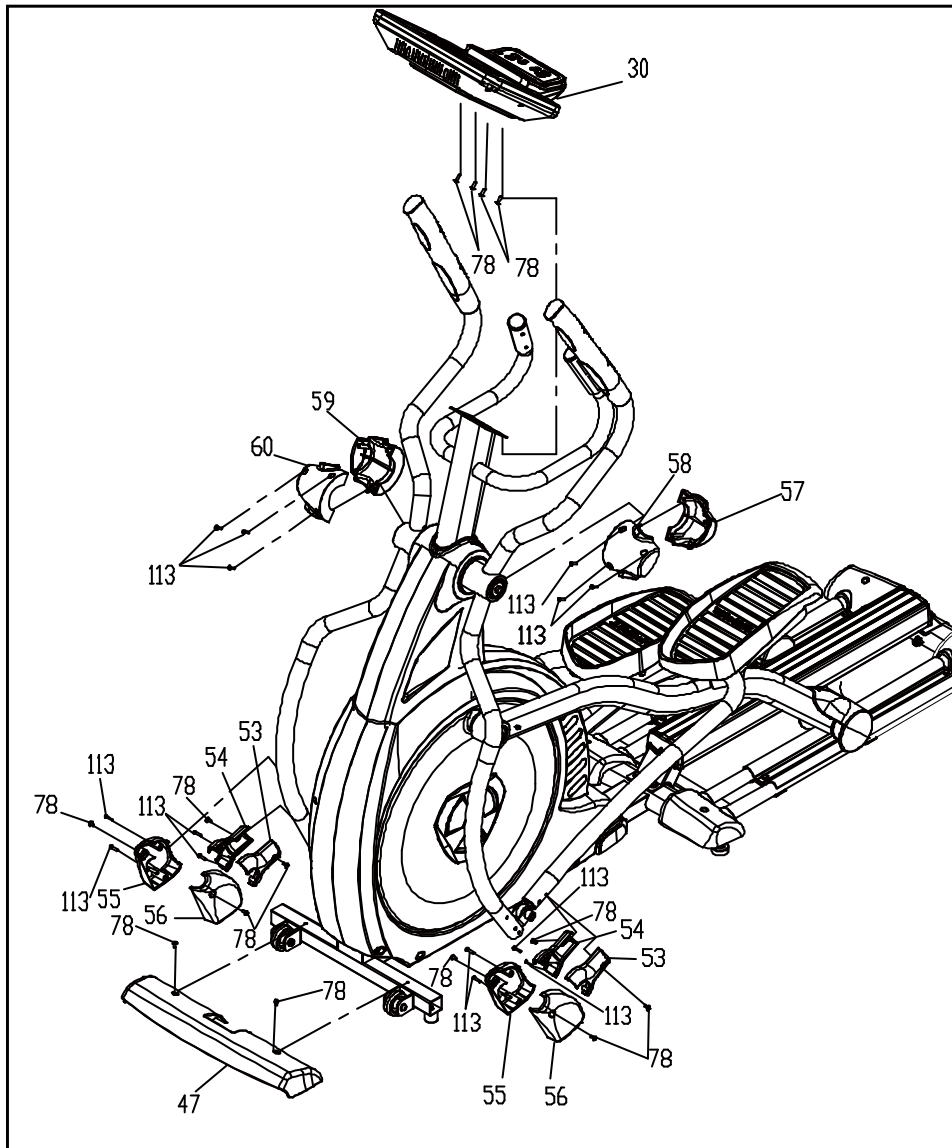

STEP 4

1. Gather **HARDWARE FOR STEP 4**.
2. Plug the **COMPUTER CABLE (30-15)** and **HEART RATE CABLES (35X2)** into the corresponding connectors on the back of the console (**30**). Mount the **CONSOLE (30)** to the **MAST** with 4 **SCREWS (78)**.
3. Install 4 **SWING ARM COVERS (57/58 left & 59/60 right)** with 6 **SCREWS (113)**.
4. Install 4 **COVERS (53X2 & 54X2)** to the ends of the **PEDAL ARMS** with 4 **SCREWS (78)** and 4 **SCREWS (113)**. Be careful not to install these covers upside down! There is an arrow on the inside of each cover to indicate the correct installation direction.
5. Install the 4 **COVERS (55 X 2 & 56 X 2)** to the connection point at the bottom of the **SWING ARMS** using 4 **SCREWS (113)** and 4 **SCREWS (78)**.
5. Install the **FRONT STABILIZER COVER (47)** with 2 **SCREWS (78)**.

■ Transportation

The elliptical is equipped with two transport wheels which are engaged when rear of the elliptical is lifted.

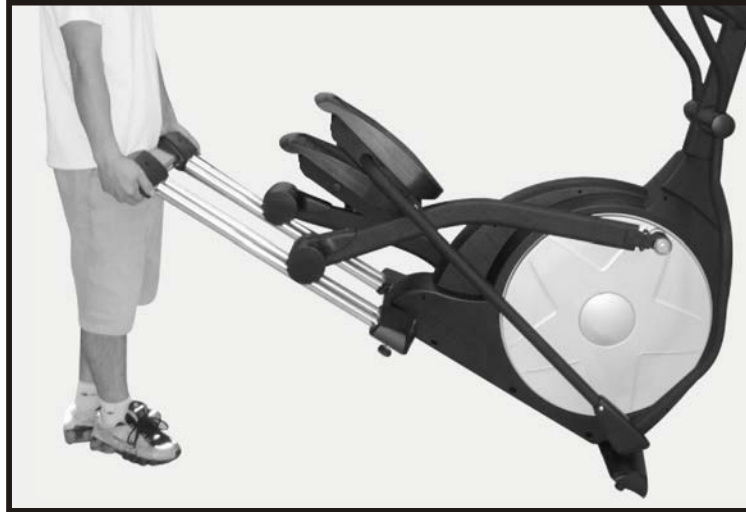

■ Elliptical Lubrication

1. Pour 2c.c of the lubricant on the middle of the rail. You must lubricate the rails every three months.
2. If you feel the exercise is not smooth or you hear noise during your exercise, lubricate the middle rail with 2 c.c.of the lubricant.



GETTING ON / OFF YOUR ELLIPTICAL

IMPORTANT

The elliptical comes with two Dual Action Handles and a Stationary Handlebar. Always hold the Stationary Handlebar when getting on and off the elliptical. First time users should familiarize themselves with using the elliptical by using the Stationary Handlebar first and then progressing to the Dual Action Handles.

Once you have familiarized yourself with using the elliptical, you can progress to using the Dual Action Handles to provide a total body workout. Hands can be positioned on the Dual Action Handles at the most appropriate position for your height and arm length.

Caution should always be taken when getting on and off any exercise machine. Please follow the safety steps below.

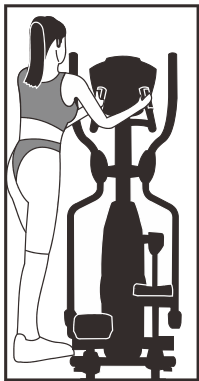

Ensure the left Foot Pedal is in the lowest position and grasp the Stationary Handlebar with both hands.

Place your left foot on the left Foot Pedal and get secure.

Lift your right foot over machine and place on right Foot Pedal. Get balanced and begin your workout.

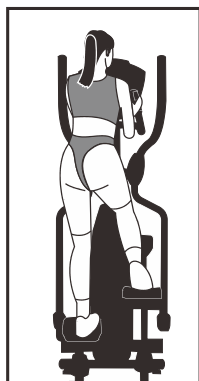
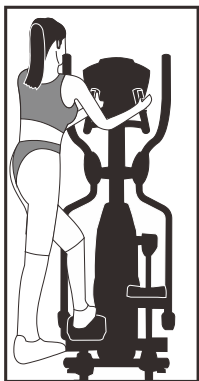

Important

To get off, come to a complete stop and reverse the procedure.

Always wear rubber-soled shoes, such as tennis shoes.

It is recommended that you keep at least one hand on the Stationary Handlebar at all times, especially when getting on or off. If you are performing a walking action with your arms, or doing upper body strength training exercises, ensure you are well balanced.

All equipment should be set-up and operated on solid, level surfaces.

Correct Position



Your body should be in an upright position so that your back is straight. Keep your head up to minimize neck and upper back strain. Always try and use the elliptical in a rhythmical and smooth motion. If you find yourself feeling uncomfortable, or experience a surging type feeling, there is probably too much tension.



The elliptical can be used in forward or reverse motion.



When going in reverse, bend your knees slightly more. More emphasis is on the buttocks and hamstrings in the reverse motion.

MOVING YOUR ELLIPTICAL

The elliptical can be easily moved.



1. At the rear of the machine squat down and grasp the rear stabilizer bar.

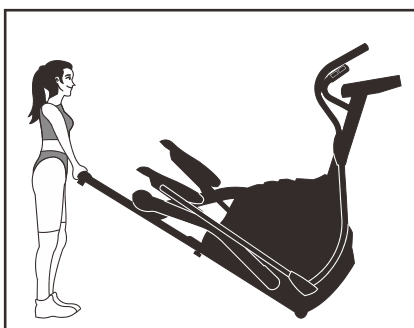

2. Lift the rear of the machine using your legs until the wheels in the front engage with the ground.

OPERATION OF YOUR CONSOLE



POWER

Spirit Fitness commercial elliptical trainers have a built-in generator for power and do not need to be plugged into an AC outlet. To power up the elliptical trainer simply start to pedal, the console will turn on automatically.

When initially powered on, the console will perform an internal self-test. During this time the display may not light up for a few seconds. Continue pedaling and the display will light up. Once powered on, the Dot Matrix Message Center will be scrolling the start-up message. You may now begin your workout program.

C-SAFE FEATURE

Your console is equipped with a C-SAFE feature. The Power (POWER) port can be used for powering a remote controlled audio-visual system by connecting a cable from the remote to the Power port at the back of the console. **The Communication port (COMM) can be used to interact with fitness software applications.**

Quick Start

This is the quickest way to start a workout. After the console powers up you just press the Start button to begin. This will initiate the Quick Start mode. In Quick Start the Time will count up from zero, all workout data will start to accrue and the workload may be adjusted manually by pressing the Level Up and Down buttons. The Dot Matrix Message Center display will show just the bottom row lit. As you increase the workload more rows will light indicating a harder workout. The elliptical trainer will get harder to pedal as the rows increase. The Dot Matrix Message Center has 24 columns of lights and each column represents 1 minute. At the end of the 24th column (or 24 minutes of work) the display will wrap around and start at the first column again.

There are 40 levels of resistance – displayed as 10 rows of lights - available for plenty of variety. The first 10 levels are very easy workloads, and the changes between levels are set to a good progression for de-conditioned users. Levels 10-20 are more challenging but the increases from one level to the next remain small. Levels 20-30 start getting tough as the levels jump more dramatically. Levels 30-40 are extremely hard and are good for short interval peaks and elite athletic training.

BASIC INFORMATION

The Dot Matrix Message Center, or Profile Window, will display the workout Profile. The LED Data Display Windows display pertinent exercise data. There is a RPM window for pedal speed and a Level window indicating machine resistance.

The LED Data Display Window will initially be displaying Distance, Calories, Pulse, and Time Elapsed information. When the Up/Down Scan button is pressed the next set of information will appear: Speed, Watts, METs, Time Remaining. Pressing the Up/Down Scan button, the Scan mode is activated and the LED Data Display Window will show each set of data for four seconds then switch to the next set of data in a continuous loop. Pressing the Up/Down Scan button again will bring you back to the beginning.

The Stop/Reset button actually has several functions. Pressing the Stop button once during a program will pause the program for 5 minutes. If you need to get a drink, answer the phone, or any of the many things that could interrupt your workout, this is a great feature. To resume your workout during Pause just press the Start button. If the Stop button is pressed twice during a workout, the program will end and the console will return to the start-up screen. If the Stop button is held down for 3 seconds, the console will perform a complete Reset. During data entry for a program the Stop performs a Previous Screen function. This allows you to go back one step in the programming each time you press the Stop button.

The Program button is used to preview each program. When you first turn the console on, you may press program key to preview what the program profile looks like. If you decide that you want to try a program, press the Enter key to select the program and enter into the data set-up mode.

1/4 MILE / 0.4 KM TRACK

The 1/4-mile track (0.4 km) will be displayed around the dot matrix window. The flashing dot indicates your progress. In the center of the track there is a lap counter for reference.

HEART RATE WINDOW

The Pulse (Heart Rate) window will display your current heart rate in beats per minute during the workout. You must use both left and right stainless steel sensors to pick up your pulse. Pulse values are displayed anytime the computer is receiving a Grip Pulse signal. You may use the Grip Pulse feature while in Heart Rate Control. The CE800 will also pick up wireless heart rate transmitters that are Polar compatible, including coded transmissions.

PROGRAMMABLE FEATURES

Each of the programs can be customized with your personal information and changed to suit your needs.

Some of the information asked for is necessary to ensure the readouts are correct. You will be asked for your Age and Weight. Your Age is necessary during the Heart Rate control program to ensure the correct settings are in the program for your Age. Otherwise the work settings could be too high or low for you; entering your Weight aides in calculating a more correct Calorie reading. Although we cannot provide an exact calorie count we do want to be as close as possible.

CALORIE NOTE: Calorie readings on every piece of exercise equipment, whether it is in a gym or at home, are not accurate and tend to vary widely. They are meant only as a guide to monitor your progress from workout to workout. The only way to measure your calorie burn accurately is in a clinical setting connected to a host of machines. This is because every person is different and burns calories at a different rate. Some good news is that you will continue to burn calories at an accelerated rate for at least an hour after you have finished exercising!

MANUAL

The Manual program works as the name implies, manually. This means that you control the workload yourself and not the computer. To start the Manual program follow the instructions below.

1. Using the Program button choose Manual then press the Enter button.
2. The Dot Matrix Message Center will ask you to enter your Age. You may enter your Age, using the Up and Down buttons, then press the Enter button to accept the new number and proceed on to the next screen.
3. You are now asked to enter your Weight. You may adjust the Weight number using the Up and Down buttons, then press enter to continue.
4. The next setting is Time. You may adjust the Time and press Enter to continue.
5. Now you are finished editing the settings and can begin your workout by pressing the Start button. You can also go back and modify your settings by pressing the Enter button.
NOTE: At any time during the editing of data you can press the Stop button to go back one level, or screen.
6. The program automatically starts you at level one. This is the easiest level and it is a good idea to stay at level one for a while to warm up. If you want to increase the work load at any time press the Level Up button; the Level Down button will decrease the workload.
7. When the program ends you may press Start to begin the same program again or Stop to exit the program.

PRESET PROGRAMS

The elliptical trainer has five different programs that have been designed for a variety of workouts. These five programs have factory preset work level profiles for achieving different goals.

HILL

This program follows a triangle or pyramid type of gradual progression from approximately 10% of maximum effort (the level that you chose before starting this program) up to a maximum effort which lasts for 10% of the total workout time, then a gradual regression of resistance back to approximately 10% of maximum effort.

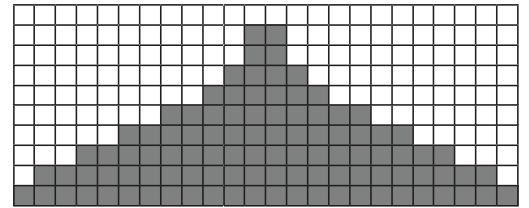

FATBURN

This program follows a quick progression up to the maximum resistance level (default or user input level) that is sustained for 2/3 of the workout. This program will challenge your ability to sustain your energy output for an extended period of time.

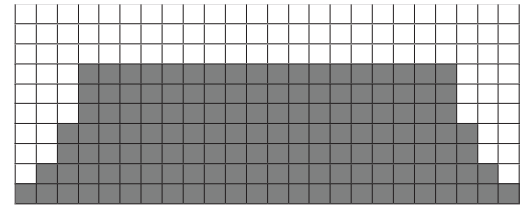

Cardio

This program presents a quick progression up to near maximum resistance level (default or user input level). It has slight fluctuations up and down to allow your heart rate to elevate, and then recover repeatedly, before beginning a quick cool down. This will build up your heart muscle and increase blood flow and lung capacity.

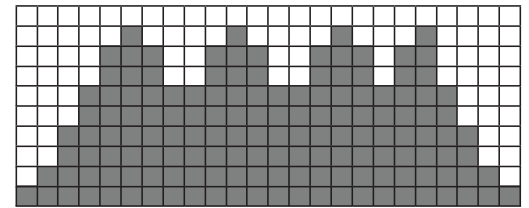

Interval

This program takes you through high levels of intensity followed by recovery periods of low intensity. This program utilizes and develops your "Fast Twitch" muscle fibers which are used when performing tasks that are intense and short in duration. These deplete your oxygen level and spike your heart rate, followed by periods of recovery and heart rate drop to replenish oxygen. Your cardiovascular system gets programmed to use oxygen more efficiently.

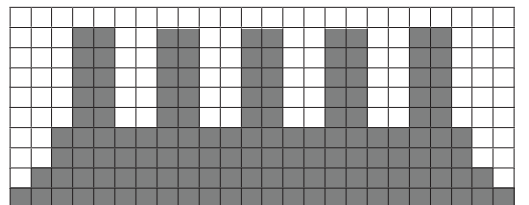

HIIT PROGRAM

The HIIT, or High Intensity Interval Training, program takes advantage of the latest trend in fitness. During the program you will perform short bursts of high intensity sprinting followed by short rest periods. HIIT is a fully customizable interval training program. You can enter the number of intervals, time of each interval Sprint and Rest periods and the work intensity of the levels.

1. Using the Program button select the HIIT program then press Enter. The Dot Matrix Message Center will ask you to enter your Age. You may enter your Age, using the Up and Down keys, then press the Enter key to accept the new number and proceed on to the next screen.
2. You are now asked to enter your Weight. You may adjust the Weight number using the Up and Down keys then press Enter to continue.
3. Next you are asked for the number of intervals you want to do. The default is 10 and the range available is 3 to 15. One interval equals 1 Sprint and 1 Rest segment.
4. Now you are asked to adjust the Sprint Level. This is the resistance level you will experience during the Sprint segments of the program. Adjust the level and then press Enter.
5. Now you are asked to adjust the Rest Level. This is the resistance level you will experience during the Rest segments of the program. Adjust the level and then press Enter.
6. Next is entering the Interval time. The Dot Matrix Message Center shows: Sprint Time:30 and Rest Time:30. The Sprint time will be blinking. You may use the up and down keys to adjust the Sprint time from 20 to 60 seconds then press Enter. The time for the Rest period will blink and you can adjust the time using the up and down keys and press Enter.
7. The LED Data Display Window will now display the total time for the HIIT workout; now press Start to begin. There is a 3-minute warm-up period before the first Sprint begins. The resistance level during warm-up is set to 5 but can be adjusted manually.
8. The Dot Matrix Message Center display in the HIIT program is a speed indication display, not a power or resistance display. During the Sprint the Dot Matrix Message Center display will show a blinking LED at the first Sprint segment. That is the target speed LED and indicates 90 pedal rpm. As you pedal faster the lights below the target speed LED light up the faster you go. When you exceed 90 rpm the target LED will move up showing you are past the target speed. You should maintain at least 90 rpm throughout the Sprint segments. The rest segments of the HIIT program are set to resistance level 5 and you can pedal at any speed you choose as your heart rate recovers. You can manually adjust the resistance levels during the Sprint and Rest segments.
9. At the end of the last Sprint there is a 2-minute cool-down period. You can bypass this by pressing the Stop key and the workout summary will be displayed.

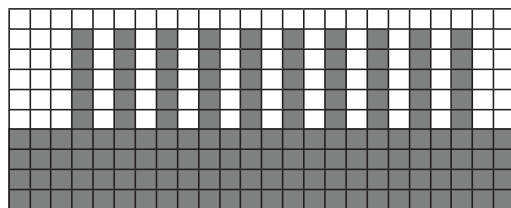

PROGRAMMING PRESET PROGRAMS

1. Using the Program button select your desired program then press the Enter button.
2. The Dot Matrix Message Center will ask you to enter your Age. You may adjust the age setting, using the Up and Down buttons, then press the Enter button to accept the new number and proceed on to the next screen.
3. You are now asked to enter your Weight. You may adjust the weight number using the Up and Down buttons, then press Enter to continue.
4. Next is Time. You may adjust the Time and press Enter to continue.
5. Now you are asked to adjust the Max Level. This is the peak exertion level you will experience during the program (at the top of the hill). Adjust the level and then press Enter.
6. Now you are finished editing the settings and can begin your workout by pressing the Start button. You can also go back and modify your settings by pressing the Stop button to go back one level, or screen.
7. If you want to increase or decrease the workload at any time during the program press the Level Up or Level Down button. This will change the workload settings of the entire profile, although the profile picture on the screen will not change. The reason for this is so that you can see the entire profile at all times. If the profile picture is changed it will look distorted and not a true representation of the actual profile. When you make a change to the workload, the Dot Matrix Message Center will show the current column, and program maximum, levels of work.
8. During the program you will be able to scroll through the data in the LED Data Display Windows by pressing the Up/Down Scan button next to the LED Data Display Windows.
9. When the program ends the LED Data Display Windows will show a summary of your workout. The summary will be displayed for a short time then the console will return to the start-up display.

CONSTANT POWER PROGRAM

A Watts program is a controllable constant power whose Level adjusts when the speed is changed. To start the Constant Power program follow the instructions below.

1. Using the Program button choose the Constant Power program, then press the Enter button.
2. The Dot Matrix Message Center will ask you to enter your Age. Input your Age, using the Up/Down buttons, then press the Enter button to accept the new age and proceed on to the next screen.
3. You are now asked to enter your Weight. Adjust Weight using the Up/Down buttons then press Enter to continue.
4. Next is Time. Adjust the Time, then press Enter to continue.
5. Now you are asked to adjust the Target Watt Level. This is the constant power you will experience during the program. Adjust using the Up/Down buttons, then press Enter.
6. Now you are finished editing the settings and can begin your workout by pressing the Start button. You can also go back and modify your settings by pressing the Enter button. NOTE: At any time during the editing of data, you can press the Stop button to go back one level, or screen.
7. If you want to increase or decrease the workload at any time during the program, press the Up/Down button. This will allow you to change your target Watt level at any time during the program.
8. During the Constant Power program you will be able to scroll through the data in the LED Data Display Window by pressing the adjacent Up/Down Scan buttons.
9. When the program ends, you may press Start to begin the same program again or Stop to exit the program.

FITNESS TEST PROGRAM

The VO2 program is based on the YMCA protocol and is a sub-maximal test that uses pre-determined, fixed work levels that are based on your heart rate readings as the test progresses. The test will take anywhere between 6 to 15 minutes to complete, depending on your level of fitness. The test ends when your heart rate reaches 85% of maximum at any time during the test or your heart rate is between 110 bpm and 85% at the end of two consecutive stages. At the end of the test a VO2max score will be given.

VO2max stands for Volume of Oxygen uptake which is a measurement of how much oxygen you need to perform a known amount of work. The YMCA protocol uses two to four, 3 minute stages of continuous exercise (see charts below). You will be asked to choose either, "Male" or "Female" at the beginning of the test. This choice determines which test parameters will be used during the test as shown in the charts below. If you are a de-conditioned male, you may want to choose the option for "Female" to assist in the correct calculations. Similarly, if you are a very conditioned female, you may want to choose the option for "Male."

Workload chart for male or very fit female:

1st Stage				Level 12 - 50 watts - 300 kgm/min					
HR		< 90			90 - 105			> 105	
2nd Stage		Level 29 - 150 watts - 900 kgm/min			Level 26 - 125 watts - 750 kgm/min			Level 23 - 100 watts - 600 kgm/min	
HR	HR <120	HR 120-135	HR >135	HR <120	HR 120-135	HR >135	HR <120	HR 120-135	HR >135
3rd stage	Level 36 - 225 watts - 1350 kgm/min	Level 34 - 200 watts - 1200 kgm/min	Level 32 - 175 watts - 1050 kgm/min	Level 34 - 200 watts - 1200 kgm/min	Level 32 - 175 watts - 1050 kgm/min	Level 29 - 150 watts - 900 kgm/min	Level 32 - 175 watts - 1050 kgm/min	Level 29 - 150 watts - 900 kgm/min	Level 26 - 125 watts - 750 kgm/min

Workload chart for female or de-conditioned male

1st Stage			Level 5 (25W) 150 kgm/min	
Heart Rate	HR<80	HR: 80-90	HR: 90-100	HR>100
2nd Stage	Level 26 (125W) 750 kgm/min	Level 23 (100W) 600 kgm/min	Level 18 (75W) 450 kgm/min	Level 12 (50W) 300 kgm/min
3rd Stage	Level 29 (150W) 900 kgm/min	Level 26 (125W) 750 kgm/min	Level 23 (100W) 600 kgm/min	Level 18 (75W) 450 kgm/min
4th Stage (if needed)	Level 32 (175W) 1050 kgm/min	Level 29 (150W) 900 kgm/min	Level 25 (117W) 700 kgm/min	Level 23 (100W) 600 kgm/min

FITNESS TEST PROGRAMMING

1. Using the Program button choose Fitness Test and press Enter.
2. The Dot Matrix Message Center will display Gender. Use the Up and Down arrows if you need to change, then press Enter. The choice of gender determines which workload chart will be used for the test.
3. The Dot Matrix Message Center will ask you to enter your Age. You may adjust the age setting, using the Up and Down buttons then press the Enter button to accept the new number and proceed on to the next screen.
4. You are now asked to enter your Weight. You may adjust the weight number using the Up and Down buttons then press Enter to continue.
5. Now press Start to begin the test.

Before the test:

- Make sure you are in good health; check with your physician before performing any exercise if you are over the age of 35 or persons with pre-existing health conditions.
- Make sure you have warmed up and stretched before taking the test.
- Do not take in caffeine before the test.
- Hold the hand grips gently, do not tense up.

During the test:

- The console must be receiving a steady heart rate for the test to begin. You may use the hand pulse sensors or wear a heart rate chest strap transmitter.
- You must maintain a steady 50 RPM pedal speed. If your pedal speed drops below 48 RPM or goes above 52 RPM the console will emit a steady beeping sound until you are within this range.
- You may scroll through the various data readings in the LED Data Display Windows by pressing the Up/Down Scan button next to the LED Data Display Windows.
- The LED Data Display Windows will always display your pedal speed on the right side to help you maintain 50RPM.
- The data shown during the test is:
 - a. **Work in KGM** is actually an abbreviated form of kg-m/min. which is a work measurement of kilogram-force meter/minute
 - b. **Work in Watts** (1 watt is equal to 6.11829727787 kg-m/min.)
 - c. **HR** is your actual heart rate; **TGT** is the target heart rate to reach to end the test.
 - d. **Time** is the total elapsed time of the test.

After the test:

- Cool down for about one to three minutes.
- Take note of your score because the console will automatically return to the start-up mode after a few minutes.

What your score means:

VO2max Chart for males and very fit females

	18-25 years old	26-35 years old	36-45 years old	46-55 years old	56-65 years old	65+ years old
excellent	>60	>56	>51	>45	>41	>37
good	52-60	49-56	43-51	39-45	36-41	33-37
above average	47-51	43-48	39-42	35-38	32-35	29-32
average	42-46	40-42	35-38	32-35	30-31	26-28
below average	37-41	35-39	31-34	29-31	26-29	22-25
poor	30-36	30-34	26-30	25-28	22-25	20-21
very poor	<30	<30	<26	<25	<22	<20

VO2max Chart for females and de-conditioned males

	18-25 years old	26-35 years old	36-45 years old	46-55 years old	56-65 years old	65+ years old
excellent	56	52	45	40	37	32
good	47-56	45-52	38-45	34-40	32-37	28-32
above average	42-46	39-44	34-37	31-33	28-31	25-27
average	38-41	35-38	31-33	28-30	25-27	22-24
below average	33-37	31-34	27-30	25-27	22-24	19-22
poor	28-32	26-30	22-26	20-24	18-21	17-18
very poor	<28	<26	<22	<20	<18	<17

CUSTOM PROGRAM

You can build your own custom program by following the instructions below.

1. Using the Program button, select Custom and then then press the Enter button to begin programming
2. Enter your name in the Dot Matrix Message Center, the letter "A" will be blinking. Use the Up/Down buttons to select the appropriate first letter of your name (pressing the Up button will switch to the letter "B"; pressing the Down button will switch to letter "Z"). Press Enter when the desired letter is displayed. Repeat this process until all of the characters of your name have been programmed (maximum 7 characters). When finished press Stop.
3. If there is a program already stored in Custom, you will have an option to run the program as it is or delete the program and build a new one. The Dot Matrix Message Center will ask: Run Program? Use the Up/Down arrows to select "Yes" or "No". If you select No, you will then be asked if you want to delete the currently saved program. It is necessary to delete the current program if you want to build a new one.
4. The Dot Matrix Message Center will ask you to enter your Age. You may enter your age, using the Up/Down buttons, then press the Enter button to accept the new value and proceed on to the next screen.
5. You are now asked to enter your Weight. You may adjust the weight value using the Up/Down buttons, then press Enter to continue.
6. Next is Time. You may adjust the time and press Enter to continue.
7. Now you are asked to adjust the Max Resistance Level of the program, press Enter when resistance has been selected.
8. Now the first column will be blinking and you are asked to adjust the resistance level for the first segment (SEGMENT > 1) of the workout by using the Up button. When you finish adjusting the first segment, or if you don't want to change, then press Enter to continue to the next segment.
9. The next segment will show the same workload resistance level as the previously adjusted segment. Repeat the same process as the last segment then press Enter. Continue this process until all twenty-four segments have been set.
10. After saving the program the Dot Matrix Message Center says "New Program Saved" then will give you the option to start or modify the program. Pressing Stop will exit to the start up screen.

HEART RATE PROGRAMS

A word about Heart Rate:

The old motto, “no pain, no gain”, is a myth that has been overpowered by the benefits of exercising comfortably. A great deal of this success has been promoted by the use of heart rate monitors. With the proper use of a heart rate monitor, many people find that their usual choice of exercise intensity was either too high or too low and exercise is much more enjoyable by maintaining their heart rate in the desired benefit range.

To determine the benefit range in which you wish to train, you must first determine your Maximum Heart Rate. This can be accomplished by using the following formula: 220 minus your age. This will give you the Maximum heart rate (MHR) for someone of your age. To determine the effective heart rate range for specific goals you simply calculate a percentage your MHR. Your Heart rate training zone is 50% to 90% of your maximum heart rate. 60% of your MHR is the zone that burns fat while 80% is for strengthening the cardiovascular system. This 60% to 80% is the zone to stay in for maximum benefit.

For someone who is 40 years old their target heart rate zone is calculated:

$$\begin{aligned} 220 - 40 &= 180 \text{ (maximum heart rate)} \\ 180 \times .6 &= 108 \text{ beats per minute (60\% of maximum)} \\ 180 \times .8 &= 144 \text{ beats per minute (80\% of maximum)} \end{aligned}$$

So for a 40 year old the training zone would be 108 to 144 beats per minute.

If you enter your age during programming the console will perform this calculation automatically. Entering your age is used for the Heart Rate control programs. After calculating your Maximum Heart Rate you can decide upon which goal you would like to pursue.

The two most popular reasons for, or goals, of exercise are cardiovascular fitness (training for the heart and lungs) and weight control. The black columns on the chart above represent the Maximum Heart Rate for a person whose age is listed at the bottom of each column. The training heart rate, for either cardiovascular fitness or weight loss, is represented by two different lines that cut diagonally through the chart. A definition of the lines' goal is in the bottom left-hand corner of the chart. If your goal is cardiovascular fitness or if it is weight loss, it can be achieved by training at 80% or 60%, respectively, of your Maximum Heart Rate on a schedule approved by your physician. Consult your physician before participating in any exercise program.

With all Heart Rate Control elliptical machines you may use the heart rate monitor feature without using the Heart Rate Control program. This function can be used during manual mode or during any of the nine different programs. The Heart Rate Control program automatically controls resistance at the pedals.

”WARNING” Heart rate monitoring system may be inaccurate. Over exercise may result in injury or death. If you feel faint stop exercising immediately.

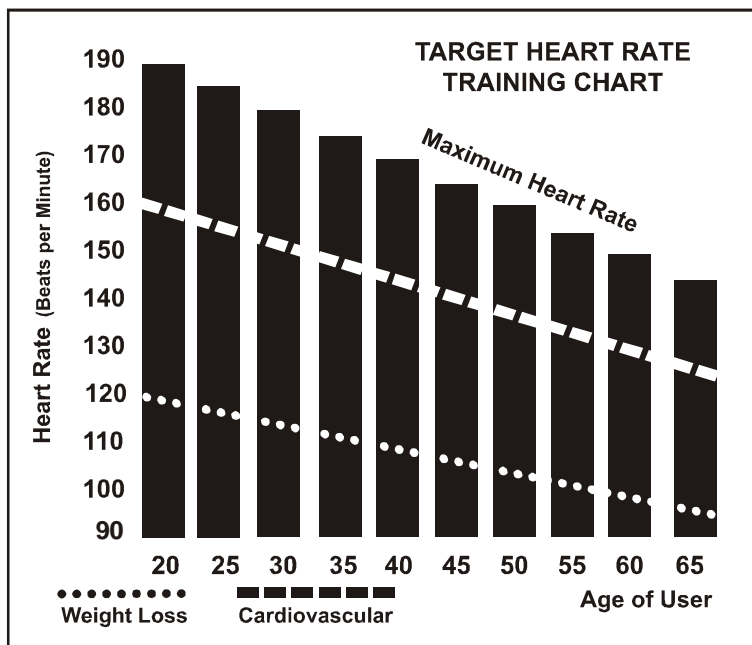

HEART RATE PROGRAM OPERATION

To start the HRC program follow the instructions below.

1. Using the Program button, choose the HR program (65% or 80%), then press the Enter key.
2. The Dot Matrix Message Center will ask you to enter your Age. You may enter your Age, using the Up/Down keys, then press the Enter key to accept the new number and proceed on to the next screen.
3. You are now asked to enter your Weight. You may adjust the Weight number using the Up/Down keys, then press Enter to continue.
4. Next is Time. You may adjust the Time and press Enter to continue.
5. Now you are asked to adjust your target Heart Rate. This is the heart rate level you will try to maintain during the program. Adjust the value and then press Enter.
6. Now you are finished editing the settings and can begin your workout by pressing the Start key. You can also go back and modify your settings by pressing the Enter key. Note: At any time during the editing of data you can press the Stop key to go back one level, or screen.
7. If you want to increase or decrease the resistance at any time during the program, press the Level Up/Down key. This will allow you to change your target heart rate at any time during the program.
8. The program will automatically increase or decrease the amount of resistance, depending on whether your heart rate is above or below your target.

RATE OF PERCEIVED EXERTION

Heart rate is important but listening to your body also has a lot of advantages. There are more variables involved in how hard you should workout than just heart rate. Your stress level, physical health, emotional health, temperature, humidity, the time of day, the last time you ate and what you ate, all contribute to the intensity at which you should workout. If you listen to your body, it will tell you all of these things.

The rate of perceived exertion (RPE), also known as the Borg scale, was developed by Swedish physiologist G.A.V. Borg. This scale rates exercise intensity from 6 to 20 depending upon how you feel or the perception of your effort.

The scale is as follows:

Rating Perception of Effort

- 6 Minimal
- 7 Very, very light
- 8 Very, very light +
- 9 Very light
- 10 Very light +
- 11 Fairly light
- 12 Comfortable
- 13 Somewhat hard
- 14 Somewhat hard +
- 15 Hard
- 16 Hard +
- 17 Very hard
- 18 Very hard +
- 19 Very, very hard
- 20 Maximal

You can get an approximate heart rate level for each rating by simply adding a zero to each rating. For example a rating of 12 will result in an approximate heart rate of 120 beats per minute. Your RPE will vary depending upon the factors discussed earlier. That is the major benefit of this type of training. If your body is strong and rested, you will feel strong and your pace will feel easier. When your body is in this condition, you are able to train harder and the RPE will support this. If you are feeling tired and sluggish, it is because your body needs a break. In this condition, your pace will feel harder. Again, this will show up in your RPE and you will train at the proper level for that day.

USING A HEART RATE TRANSMITTER (OPTIONAL)

How to wear your wireless chest strap transmitter:

1. Attach the transmitter to the elastic strap using the locking parts.
2. Adjust the strap as tightly as possible as long as the strap is not too tight to remain comfortable.
3. Position the transmitter with the logo centered in the middle of your body facing away from your chest (some people must position the transmitter slightly left of center). Attach the final end of the elastic strap by inserting the round end and, using the locking parts, secure the transmitter and strap around your chest.
4. Position the transmitter immediately below the pectoral muscles.
5. Sweat is the best conductor to measure very minute heart beat electrical signals. However, plain water can also be used to pre-wet the electrodes (2 black square areas on the reverse side of the belt and either side of transmitter). It's also recommended that you wear the transmitter strap a few minutes before your work out. Some users, because of body chemistry, have a more difficult time in achieving a strong, steady signal at the beginning. After "warming up", this problem lessens. As noted, wearing clothing over the transmitter/strap doesn't affect performance.
6. Your workout must be within range - distance between transmitter/receiver – to achieve a strong steady signal. The length of range may vary somewhat but generally stay close enough to the console to maintain good, strong, reliable readings. Wearing the transmitter immediately against bare skin assures you of proper operation. If you wish, you may wear the transmitter over a shirt. To do so, moisten the areas of the shirt that the electrodes will rest upon.



Note: The transmitter is automatically activated when it detects activity from the user's heart. Additionally, it automatically deactivates when it does not receive any activity. Although the transmitter is water resistant, moisture can have the effect of creating false signals, so you should take precautions to completely dry the transmitter after use to prolong battery life (estimated transmitter battery life is 2500 hours). If your chest strap has a replaceable battery the replacement battery is Panasonic CR2032.

ERRATIC OPERATION

Caution! Do not use this elliptical for Heart Rate Control unless a steady, solid Actual Heart Rate value is being displayed. High, wild, random numbers being displayed indicate a problem.

Areas to look at for interference, which may cause erratic heart rate:

1. Microwave ovens, TV's, small appliances, etc.
2. Fluorescent lights.
3. Some household security systems.
4. Perimeter fence for a pet.
5. Some people have problems with the transmitter picking up a signal from their skin. If you have problems try wearing the transmitter upside down.
6. The antenna that picks up your heart rate is very sensitive. If there is an outside noise source, turning the whole machine 90 degrees may de-tune the interference.
7. Another Individual wearing a transmitter within 3' of your machine's console.

If you continue to experience problems contact Dyaco Canada Inc.

GENERAL MAINTENANCE

Wipe down all areas in the sweat path with a damp cloth after each workout.

2. If a squeak, thump, clicking or rough feeling develops the main cause is most likely one of two reasons:
 - a. The hardware was not sufficiently tightened during assembly. All bolts that were installed during assembly need to be tightened as much as possible. It may be necessary to use a larger wrench than the one provided if you cannot tighten the bolts sufficiently. I cannot stress this point enough; 90% of calls to the service department for noise issues can be traced to loose hardware.
 - b. The crank arm nut needs to be retightened
 - c. If squeaks or other noises persist, check that the unit is properly leveled. There are 2 leveling pads on the bottom of the rear stabilizer, 2 on the bottom of the middle stabilizer and 2 underneath the rail assembly. Use a 14mm wrench (or adjustable wrench) to adjust the levelers.

ENGINEERING MODE

To enter the Maintenance Mode, pedal the elliptical and press and hold down the Start, Stop and Enter keys. Keep holding the keys down for about 5 seconds and the Dot Matrix Message Center will display Maintenance Mode. Press the Enter key to access the menu below:

1. Key Test (Will allow you to test all the keys to make sure they are functioning)
2. Display Test (Tests all the display functions)
3. Function
 - Units - Sets the display to read out in Imperial (miles, pounds, feet, etc.) or Metric (kilometers, kilograms, meters, etc.) display measurements
 - Pause mode (have five minutes)
 - Odometer Reset (Resets the odometer)
 - Beep sound (Control Beep)
4. Service
 - PWM test (Test the Brake resistance)
 - C safe test
 - Sensor test (Test the speed sensor function)
5. Exit

EXPLODED VIEW DIAGRAM

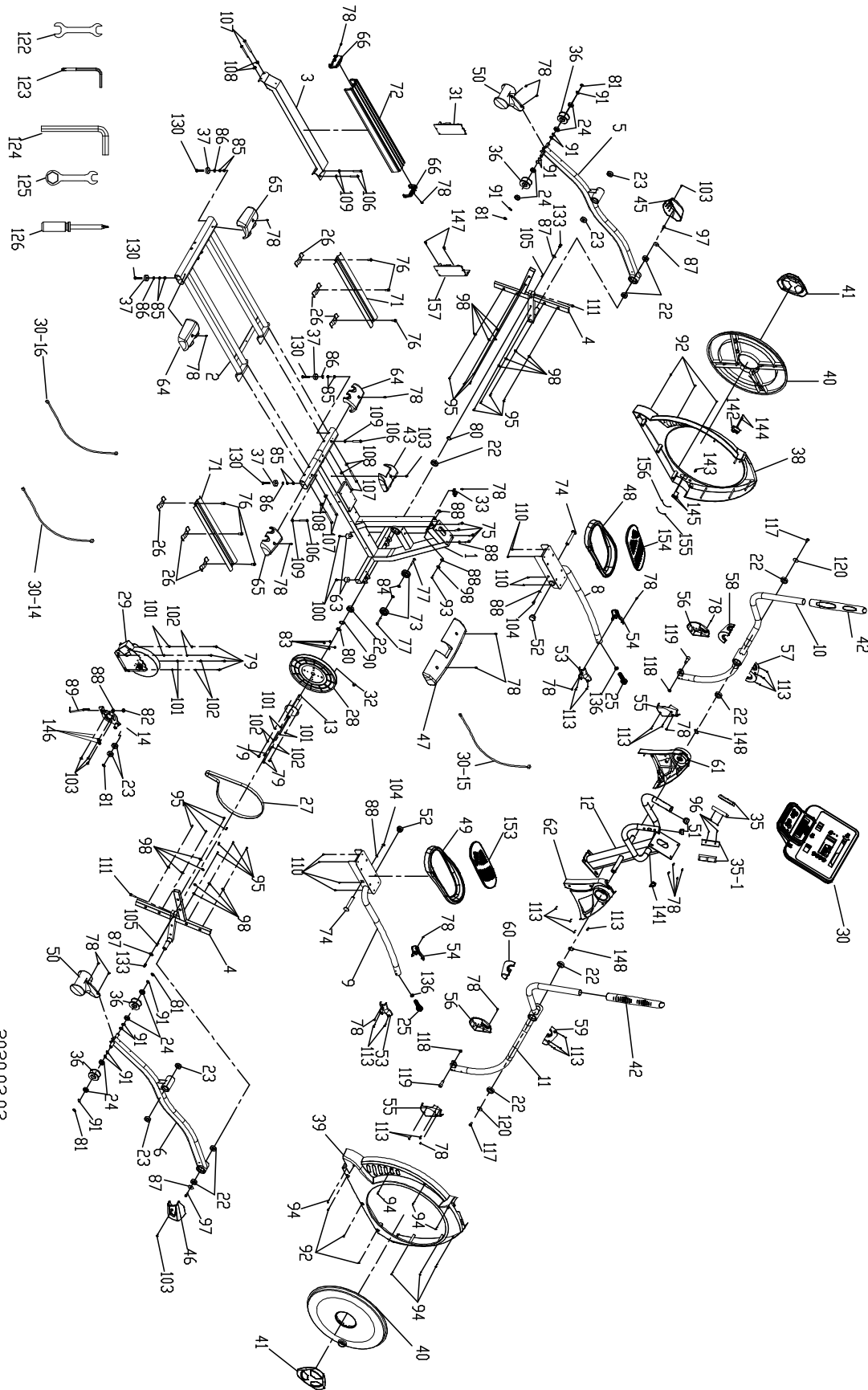

2020.03.03

PARTS LIST

KEY NO.	PART NO.	DESCRIPTION	Q'TY
1	BB010103-S13	Main Frame	1
2	RBB030051-S13	Rail Assembly	1
3	BB070058-S13	Rail Support Assembly	1
4	RBB040006-S13	Cross Bar	2
5	RBB050072-S13	Pedal Arm(L)	1
6	RBB050073-S13	Pedal Arm(R)	1
8	RBB050074-S13-02	Connecting Arm (L)	1
9	RBB050075-S13-02	Connecting Arm (R)	1
10	RBB060175-S13	Swing Arm (L)	1
11	RBB060176-S13	Swing Arm (R)	1
12	RBB020126-S13	Console Mast	1
13	RC140009A	Crank Axle	1
14	RB140043-S13	Idler Wheel Assembly	1
22	K056005-A2	6005_Bearing(NTN)	10
23	K056203-A2	6203_Bearing	6
24	K056003-A2	6003_Bearing	8
25	K050007	Rod End Bearing	2
26	B132400-S13	Retaining Bracket, Aluminum Track	6
27	N010002	Drive Belt	1
28	PP060090-A1-B	Drive Pulley, 330mm	1
29	K500004	Flywheel	1
30	RZESE0270-21	Console Assembly	1
31	D151085	Generator/Brake Controller	1
32	N040002	Magnet	1
33	F030433	Sensor W/Cable	1
35	F090204-01	850m/m_Handpulse W/Cable Assembly	1
35~1	F090204-02	850m/m_Handpulse W/Cable Assembly(Red)	1
36	RP050030B	Sliding Wheel , Urethane	4
37	RP060256-A1	Rubber Foot	4
38	RPP060075D-I1-01	Side case (L)	1
39	RPP060076-I1-03	Side case (R)	1
40	RP060077-I1	Round Disk	2
41	PP110014-I1	Round Disk Cover	2
42	P210009-A1	Handle Bar Axle Inner Cover	2
43	P190017-I1	Incline Bottom Cover	1
45	P180042-I1	Pedal Arm Cover (L)	1
46	P180043-I1	Pedal Arm Cover (R)	1
47	PP190001-I1	Front Stabilizer Cover	1
48	PP130015A-A1	Pedal (L)	1
49	PP130016A-A1	Pedal (R)	1
50	P060162-I1	Slide Wheel Cover	2
51	P060253-A1	Button Head Plug	2
52	P040035-A1	Pedal End Cover	2

KEY NO.	PART NO.	DESCRIPTION	Q'TY
53	P180001-I1	Connecting Arm Cover A (R)	2
54	P180002-I1	Connecting Arm Cover A (L)	2
55	P180003-I1	Connecting Arm Cover B (R)	2
56	P180004-I1	Connecting Arm Cover B (L)	2
57	P180046-I1	Front Handle Bar Cover (L)	1
58	P180047-I1	Rear Handle Bar Cover (L)	1
59	P180048-I1	Front Handle Bar Cover (R)	1
60	P180049-I1	Rear Handle Bar Cover (R)	1
61	PP100050-I1	Console Mast Cover(L)	1
62	PP100051-I1	Console Mast Cover(R)	1
63	P060252-A1	Rubber Foot Pad	2
64	P060089-I1	Rear Stabilizer Cover (A)	2
65	P060164-I1	Rear Stabilizer Cover (B)	2
66	P040078-I1	End Cap, Aluminum Step Rail	2
71	M030002-Z0	Aluminum Track	2
72	M040001	Aluminum Step Rail	1
73	P050015-A1	Transportation Wheel	2
74	C050036	Ø17 x 117m/m_Carriage Bolt	2
75	J033005-Z1	M8 x 1.25 x 25m/m_Hex Socket Cap Screw	4
76	J010502	5/16" x 3/4" _Hex Head Bolt	6
77	J020508AB	5/16" x 2" _Button Head Socket Bolt	2
78	J092002-Z1	M5 x P0.8 x 12m/m_Phillips Head Screw	25
79	J010002-ZZ	1/4" x 3/4" _Hex Head Bolt	8
80	J310001-Z4	Ø25_C Ring	2
81	J310002-Z4	Ø17_C Ring	5
82	J139262-Y3	M8 x 9T_Nyloc Nut	1
83	J139461	1/4" _Nyloc Nut	4
84	J139062	5/16" x 7t_Nyloc Nut	2
85	J129021	3/8" x 7T_Nut	8
86	J210003	3/8" x 19 x 1.5T_Flat Washer	4
87	J210001-Z1	5/16" x 35 x 1.5T_Flat Washer	4
88	J210009	5/16" x 23 x 1.5T_Flat Washer	6
89	J083012K	M8 x 170m/m_J Bolt	1
90	J250001-Z4	Ø25_Wave Washer	1
91	J250002	Ø17_Wave Washer	12
92	J367105	5 x 16m/m_Tapping Screw	6
93	J396917	4 x 15m/m_Sheet Metal Screw	1
94	J526915	4 x 19m/m_Sheet Metal Screw	7
95	J377105	5 x 16m/m_Tapping Screw	16
96	J517007	3 x 20m/m_Tapping Screw	4
97	J030520-YQ	5/16" x UNC18 x 15L_Socket Head Cap Bolt	2
98	J210012	1/4" x 19m/m_Flat Washer	17
100	J367114-Z1	5 x 19m/m_Tapping Screw	2
101	J210016	Ø6.5 x 13 x 1T_Flat Washer	8
102	J260006	1/4" _Split Washer	8
103	J092503-Z1	M6 x 15m/m_Phillips Head Screw	6
104	J010520-ZG	5/16" x 15m/m_Hex Head Bolt	2

KEY NO.	PART NO.	DESCRIPTION	Q'TY
105	J320002-Z2	Woodruff Key	2
106	J021009S2-ZJ	3/8" x 2-1/4" _Button Head Socket Bolt	4
107	J021015L-ZJ	3/8" x 3-3/4" _Button Head Socket Bolt	6
108	J220004-Z1	3/8" x 23 x 2T _Curved Washer	6
109	J210003-Z1	3/8" x 19 x 1.5T _Flat Washer	4
110	J092001-Z9	M5 x 10m/m _Phillips Head Screw	8
111	J033006-ZK	M8 x 30m/m _Socket Head Cap Bolt	2
113	J396804-Z1	Ø3.5 x 12m/m _Sheet Metal Screw	18
117	J011002-ZR	3/8" x 3/4" _Hex Head Bolt	2
118	J139361-Z1	M10 _Nut	2
119	J080003P-Z1	M10 x 1.5(38mm) _Bolt	2
120	J210022-Z1	3/8" x 30 x 2.0T _Flat Washer	2
122	J330004	13.14m/m _Wrench	1
123	J330009	Combination M6 Allen Wrench & Phillips Head Screw Driver	1
124	J330013-Z1	M12 _L Allen Wrench	1
125	J330015-Z1	17m/m _Combination Wrench	1
126	J330008	Phillips Head Screw Driver	1
130	J341008	3/8" x 16UNC-2 _Flat Head Socket Bolt	4
133	J010519	5/16" x 18UNC x 12m/m _Nylock Screw	2
136	J129522	M14 x 2.0 x 7m/m _Nut	2
141	P040153-A1	Bolt Access Cap(37x36)	1
142	F030053	AC Electronic Module	1
143	E100009	TV Adapter(5C2V)	1
144	J094502-Z1	M4 x P0.7 x 12L _Phillips Head Screw	2
145	J139411-Z1	M4 x P0.7 x 5T _Nut	2
147	J367114-ZF	5 x 19m/m _Tapping Screw	2
148	J250009-Z4	Ø25 x 0.5T _Wave Washer	2
153	P120025-A1	Pedal Foam (L)	1
154	P120026-A1	Pedal Foam (R)	1
155	E010083	80m/m _Connecting Wire (White)	1
156	E010084	80m/m _Connecting Wire (Black)	1
157	B070121-S13	Plate	1

TRAINING GUIDELINES

Exercise

Exercise is one of the most important factors in the overall health of an individual. Listed among its benefits are:

- Increased capacity for physical work (strength endurance)
- Increased cardiovascular (heart and arteries/veins) and respiratory efficiency
- Decreased risk of coronary heart disease
- Changes in body metabolism, e.g. losing weight
- Delaying the physiological effects of age
- Physiological effects, e.g. reduction in stress, increase in self-confidence, etc.

Basic Components of Physical Fitness

There are four all encompassing components of physical fitness and we need to briefly define each and clarify its role.

Strength is the capacity of a muscle to exert a force against resistance. Strength contributes to power and speed and is of great importance to a majority of sports people.

Muscular Endurance is the capacity to exert a force repeatedly over a period of time, e.g. it is the capacity of your legs to carry you 10 Km without stopping.

Flexibility is the range of motion about a joint. Improving flexibility involves the stretching of muscles and tendons to maintain or increase suppleness, and provides increased resistance to muscle injury or soreness.

Cardio-Respiratory Endurance is the most essential component of physical fitness. It is the efficient functioning of the heart and lungs

Aerobic Fitness

The largest amount of oxygen that you can use per minute during exercise is called your maximum oxygen uptake (MVo₂). This is often referred to as your aerobic capacity.

The effort that you can exert over a prolonged period of time is limited by your ability to deliver oxygen to the working muscles. Regular vigorous exercise produces a training effect that can increase your aerobic capacity by as much as 20 to 30%. An increased MVO₂ indicates an increased ability of the heart to pump blood, of the lungs to ventilate oxygen and of the muscles to take up oxygen.

Anaerobic Training

This means “without oxygen” and is the output of energy when the oxygen supply is insufficient to meet the body’s long term energy demands. (For example, 100 meter sprint).

The Training Threshold

This is the minimum level of exercise which is required to produce significant improvements in any physical fitness parameter.

Progression

As you become fitter, a higher intensity of exercise is required to create an overload and therefore provide continued improvement

Overload

This is where you exercise at a level above that which can be carried out comfortably. The intensity, duration and frequency of exercise should be above the training threshold and should be gradually increased as the body adapts to the increasing demands. As your fitness level improves, so the training threshold should be raised.

Working through your program and gradually increasing the overload factor is important.

Specificity

Different forms of exercise produce different results. The type of exercise that is carried out is specific both to the muscle groups being used and to the energy source involved.

There is little transfer of the effects of exercise, i.e. from strength training to cardiovascular fitness. That is why it is important to have an exercise program tailored to your specific needs.

Reversibility

If you stop exercising or do not do your program often enough, you will lose the benefits you have gained. Regular workouts are the key to success.

Warm Up

Every exercise program should start with a warmup where the body is prepared for the effort to come. It should be gentle and preferably use the muscles to be involved later.

Stretching should be included in both your warmup and cool down, and should be performed after 3-5 minutes of low intensity aerobic activity or callisthenic type exercise.

Warm Down or Cool Down

This involves a gradual decrease in the intensity of the exercise session. Following exercise, a large supply of blood remains in the working muscles. If it is not returned promptly to the central circulation, pooling of blood may occur in the muscles.

Heart Rate

As you exercise, so the rate at which your heart beat also increases. This is often used as a measure of the required intensity of exercise. You need to exercise hard enough to condition your circulatory system, and increase your pulse rate, but not enough to strain your heart.

Your initial level of fitness is important in developing an exercise program for you. If you are starting off, you can get a good training effect with a heart rate of 110-120 beats per minute(BPM). If you are fitter, you will need a higher threshold of stimulation.

To begin with, you should exercise at a level that elevates your heart rate to about 65 to 70% of your maximum. If you find this is too easy, you may want to increase it, but it is better to lean on the conservative side.

As a rule of thumb, the maximum heart rate is 220 minus your age. As you increase in age, so your heart, like other muscles, loses some of its efficiency. Some of its natural loss is won back as fitness improves.

The following table is a guide to those who are “starting fitness”.

Age	25	30	35	40	45	50	55	60	65
Target heart Rate 10 Second Count	23	22	22	21	20	19	19	18	18
Beats per Minute	138	132	132	126	120	114	114	108	108

Pulse Count

The pulse count (on your wrist or carotid artery in the neck, taken with two index fingers) is done for ten seconds, taken a few seconds after you stop exercising. This is for two reasons: (a) 10 seconds is long enough for accuracy, (b) the pulse count is to approximate your BPM rate at the time you are exercising. Since heart rate slows as you recover, a longer count isn't as accurate.

The target is not a magic number, but a general guide. If you're above average fitness, you may work quite comfortably a little above that suggested for your age group.

The following table is a guide to those who are keeping fit. Here we are working at about 80% of maximum.

Age	25	30	35	40	45	50	55	60	65
Target heart Rate									
10 Second Count	26	26	25	24	23	22	22	21	20
Beats per Minute	156	156	150	144	138	132	132	126	120

Don't push yourself too hard to reach the figures on this table. It can be very uncomfortable if you overdo it. Let it happen naturally as you work through your program. Remember, the target is a guide, not a rule, a little above or below is just fine.

Two final comments: (1) don't be concerned with day to day variations in your pulse rate, being under pressure or not enough sleep can affect it; (2) your pulse rate is a guide, don't become a slave to it.

Endurance Circuit Training

Cardiovascular endurance, muscle, strength, flexibility and coordination are all necessary for maximum fitness. The principle behind circuit training is to give a person all the essentials at one time by going through your exercise program moving as fast as possible between each exercise. This increases the heart rate and sustains it, which improves the fitness level. Do not introduce this circuit training effect until you have reached an advanced program stage.

Body Building

Is often used synonymously with strength training. The fundamental principal here is OVERLOAD. Here, the muscle works against greater loads than usual. This can be done by increasing the load you are working against.

Patronization

This is the term used to vary your exercise program for both physiological and psychological benefits. In your overall program, you should vary the workload, frequency and intensity. The body responds better to variety and so do you. In addition, when you feel yourself getting 'stale', bring in periods of lighter exercise to allow the body to recuperate and restore its reserves. You will enjoy your program more and feel better for it.

Muscle Soreness

For the first week or so, this may be the only indication you have that you are on an exercise program. This, of course, does depend on your overall fitness level. A confirmation that you are on the correct program is a very slight soreness in most major muscle groups. This is quite normal and will disappear in a matter of days.

If you experience major discomfort, you may be on a program that is too advanced or you have increased your program too rapidly.

If you experience PAIN during or after exercise, your body is telling you something.

Stop exercising and consult your doctor.

What to Wear

Wear clothing that will not restrict your movement in any way while exercising. Clothes should be light enough to allow the body to cool. Excessive clothing that causes you to perspire more than you normally would while exercising, gives you no advantage. The extra weight you lose is body fluid and will be replaced with the next glass of water you drink. It is advisable to wear a pair of gym or running shoes or "sneakers".

Breathing during Exercise

Do not hold your breath while exercising. Breathe normally as much as possible. Remember, breathing involves the intake and distribution of oxygen, which feeds the working muscles.

Rest periods

Once you start your exercise program, you should continue through to the end. Do not break off halfway through and then restart at the same place later on without going through the warm-up stage again.

The rest period required between strength training exercises may vary from person to person. This will depend mostly on your level of fitness and the program you have chosen. Rest between exercises by all means, but do not allow this to exceed two minutes. Most people manage with half minute to one minute rest periods.

STRETCHING

Stretching should be included in both your warm up and cool down, and should be performed after 3-5 minutes of low intensity aerobic activity or callisthenic type exercise. Movements should be performed slowly and smoothly, with no bouncing or jerking. Move into the stretch until slight tension, not pain, is felt in the muscle and hold for 20-30 seconds. Breathing should be slow, rhythmical and under control, making sure never to hold your breath.

HEAD ROLLS

Rotate your head to the right for one count, feeling the stretch up the left side of your neck. Next rotate your head back for one count, stretching your chin to the ceiling and letting your mouth open. Rotate your head to the left for one count, and finally, drop your head to your chest for one count.

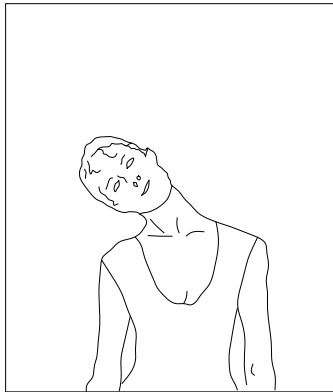

SHOULDER LIFTS

Lift your right shoulder up toward your ear for one count. Then lift your left shoulder up for one count as you lower your right shoulder.

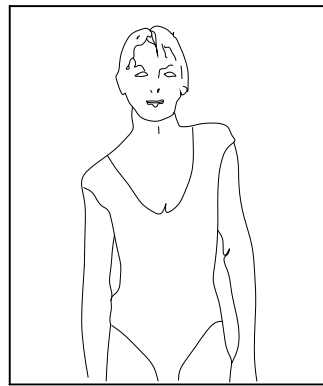

SIDE STRETCHES

Open your arms to the side and continue lifting them until they are over your head. Reach your right arm as far upward toward the ceiling as you can for one count. Feel the stretch up your right side. Repeat this action with your left arm.

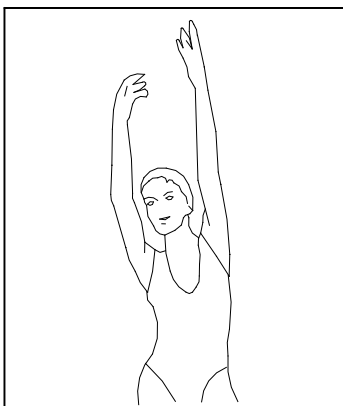

QUADRICEPS STRETCH

With one hand against a wall for balance, reach behind you and pull your right foot up. Bring your heel as close to your buttocks as possible. Hold for 15 counts and repeat with left foot up.

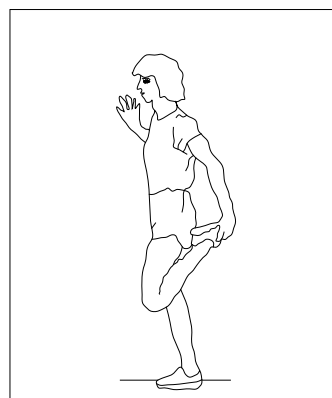

INNER THIGH STRETCH

Sit with the soles of your feet together with your knees pointing outward. Pull your feet as close into your groin as possible. Gently push your knees towards the floor. Hold for 15 counts.

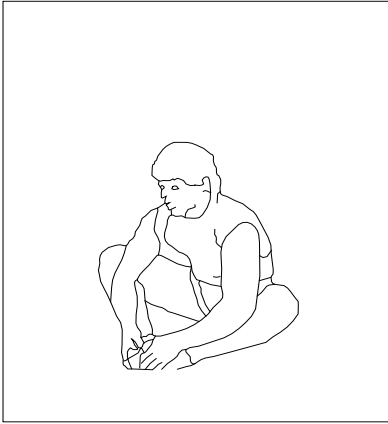

TOUCHES

Slowly bend forward from your waist, letting your back and shoulders relax as you stretch toward your toes. Reach down as far as possible.

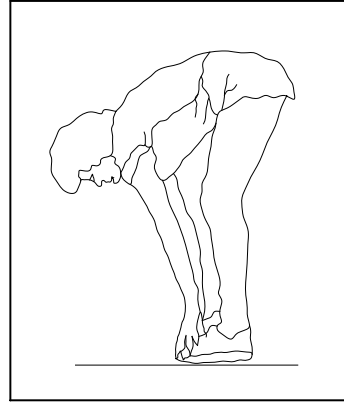

HAMSTRING STRETCHES

Sit with your right leg extended. Rest the sole of your left foot against your right inner thigh. Stretch as far as possible. Hold for 15 counts. Relax and then repeat with left leg extended.

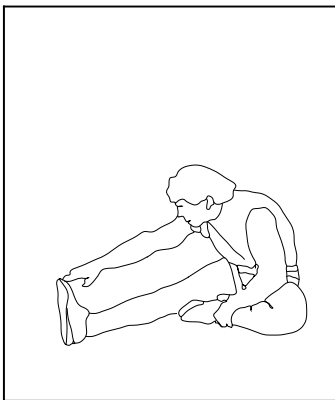

CALF / ACHILLES STRETCH

Lean against a wall with your left leg in front of the right and your arms forward. Keep your right leg straight and the left foot on the floor then bend the left leg and lean forward by moving your hips toward the wall. Hold, then repeat on the other side for 15 counts.

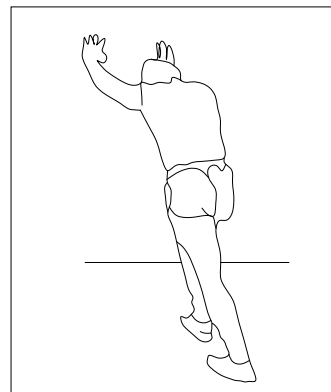

MANUFACTURER'S LIMITED WARRANTY

Dyaco Canada Inc. warrants all its elliptical parts for a period of time listed below, from the date of retail sale, as determined by a sales receipt or in the absence of a sales receipt. Dyaco Canada Inc.'s responsibilities include providing new or remanufactured parts, at Dyaco Canada Inc.'s option, and technical support to our independent dealers and servicing organizations. In the absence of a dealer or service organization, these warranties will be administered by Dyaco Canada Inc. directly to a consumer. The warranty period applies to the following components:

Home Warranty		Commercial Warranty (Non-dues paying facility)	
Frame	Lifetime	Frame	Lifetime
Electronics	10 Years	Electronics	5 Years
Parts	10 Years	Parts	5 Years
Labour	2 Years	Labour	2 Years

This warranty is not transferable and is extended only to the original owner. The warranty shall not apply to exercise units which are (1) used for commercial or other income producing purposes, or (2) subject to misuse, neglect, accident or unauthorized repair and alterations. This warranty provided herein is lieu of all other express warranties, any implied warranties, including any implied warranties of merchantability of fitness for particular purpose, are limited in duration to the first 24 months from date of purchase. All other obligations or liabilities, including liability for consequential damages are hereby excluded.

REPAIR PARTS AND SERVICE

All of the parts for the elliptical shown in figure can be ordered from Dyaco Canada Inc. 5955 DON MURIE STREET, NIAGARA FALLS, ON L2G 0A9. When ordering parts, the parts will be sent and billed at the current prices. Prices may be subject to change without notice. Check or money order must accompany all orders. Standard hardware items are available at your local hardware store.

To ensure prompt and correct handling of any errors, or to answer any questions, please call our Toll Free number: 1-888-707-1880, or local number 1-905-353-8955 or fax 1-905-353-8968 or email customerservice@dyaco.ca or visit us at www.dyaco.ca. Office hours are from 8:30 AM to 5:00 PM Monday to Friday Eastern Standard Time.

Always include the following information when ordering parts

- _ Model number
- _ Name of each part
- _ Part number of each part

dyaco

Please visit us online for information about our other brands and products manufactured and distributed by Dyaco Canada Inc.

SPIRIT

spiritfitness.ca

X XTERRA

xterrafitness.ca

UFC

dyaco.ca/UFC/UFC-home.html

SOLE
FITNESS

solefitness.ca

EVERLAST

dyaco.ca/products/everlast.html

Johnny G
by SPIRIT

spiritfitness.ca/johnnyg.html

TRAINOR
SPORTS
trainorsports.ca

For more information, please contact Dyaco Canada Inc.
T: 1-888-707-1880 | 5955 Don Murie St., Niagara Falls, Ontario L2G 0A9 | sales@dyaco.ca

Dyaco Canada Inc. dyaco.ca